

# Counterbalance Cartridge Valves

<i>Cartridge Type</i>	<i>Page</i>
Counterbalance Technical Information	52
	54
	55
	56
	57
	58
	59
	60
	61
	62

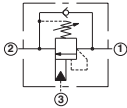
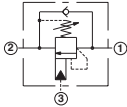
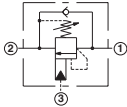
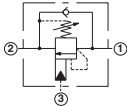
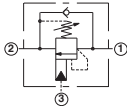
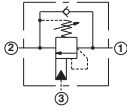
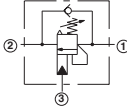
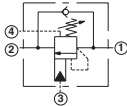
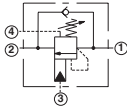
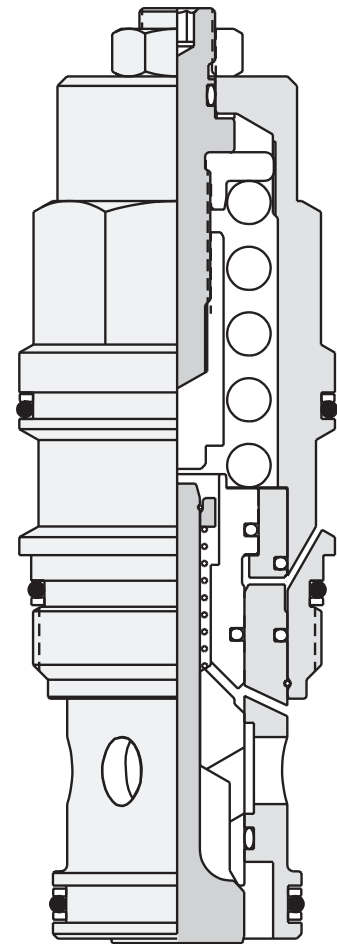

# COUNTERBALANCE CARTRIDGE VALVE TECHNICAL INFORMATION

## Adjustment Range

<b>A, H:</b>	70-280 bar	– Standard Setting 210 bar
<b>B, I:</b>	30-105 bar	– Standard Setting 70 bar
<b>C, J:</b>	140-350 bar	– Standard Setting 210 bar
<b>D, K:</b>	70-175 bar	– Standard Setting 140 bar
<b>F:</b>	70-175 bar	– Standard Setting 140 bar
<b>G:</b>	140-420 bar	– Standard Setting 280 bar

## Cracking Pressure of Reverse Free Flow Check

Valves with pressure range A, B, C, D have a .3 bar cracking pressure for the reverse free flow check. All others are 1.5 to 3 bar cracking pressure. In applications with loads that change quickly, higher cracking pressures are recommended.

## Influence of Back Pressure

Pressure downstream of the counterbalance valve (port 2) is additive to the setting with the given factor (influence of back pressure). The setting is the load pressure (on port 1) that opens the valve with no pilot pressure (on port 3).

In applications with proportional valves that throttle the return flow, Sun recommends using vented counterbalance valves (CW\*\* or CA\*\*). CW\*\* counterbalance valves have a spring chamber drained to port 4. CA\*\* valves have an atmospherically vented spring chamber. CA\*\* valves can be used when some external leakage (drops) is acceptable. The spring chamber cannot corrode due to splash water.

## Stability

Circuits with counterbalance valves can be unstable. In most cases the circuit will be more stable after replacing the counterbalance valve with a valve that has a lower pilot ratio or is restrictive or smaller. Pilot ratio 3:1 is very common and works in most cases.

## Notes (see numbers within table at right)

(1) Fully restrictive valves have a very limited flow capacity as relief valves. Counterbalance restrictive valves can be used to limit the pressure due to thermal expansion.

(2) These counterbalance valves have an internal bleed-off orifice between port 3 and 2 to reduce the effective pilot ratio. The pilot flow between port 3 and 2 is about .6 L/min. at 70 bar pilot pressure.

(3) These valves have no sealed pilot piston. The leakage from port 3 to port 2 is .93 L/min. at 70 bar pilot pressure.

(4) These are valves with no sealed pilot piston. Leakage between port 3 and port 2 is between .03 and .3 L/min. The high leakage occurs when the pilot pressure is half the load pressure or higher.

CBCA and CBEA are available with sealed pilot piston (these would be custom numbered valves).

All Model Codes shown in boldface type are in the counterbalance section of this catalogue. Consult [www.sunhydraulics.com](http://www.sunhydraulics.com) for our complete line of counterbalance cartridge products.

## Cavity Adapters

<b>T-17A to T-2A:</b>	XHOC-BXN
<b>T-17A to T-11A:</b>	XHOC-EXN
<b>T-19A to T-17A:</b>	XJOC-GXN
<b>T-23A to T-22A:</b>	XPOC-NXN
<b>T-24A to T-23A:</b>	XQOC-PXN

## COUNTERBALANCE CARTRIDGE VALVES / NON-VENTED

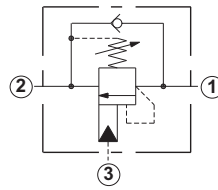

### Fully Restrictive

Fully Restrictive		Series 1	
<b>Cavity</b>	T-11A	<b>Model Code</b>	<b>Adjustment Range</b>
<b>Nominal Capacity</b>	10 L/min.	CBAB	H; I; A; B
		CBAA	H; I; A; B
		CBAG	J; K; C; D

### Restrictive (1)

Restrictive (1)		Series 1	
<b>Cavity</b>	T-11A	<b>Model Code</b>	<b>Adjustment Range</b>
<b>Nominal Capacity</b>	20 L/min.	<b>CBBY (2)</b>	H; I; A; B
		<b>CBBA</b>	H; I; A; B
		<b>CBBG</b>	J; K; C; D
		<b>CBBH (3)</b>	J; K; C; D

### Semi-restrictive

Semi-restrictive		Series 1	
<b>Cavity</b>	T-11A	<b>Model Code</b>	<b>Adjustment Range</b>
<b>Nominal Capacity</b>	40 L/min.	<b>CBBB</b>	H; I; A; B
		<b>CBBL</b>	J; K; C; D
		<b>CBBC</b>	H; I; A; B
		<b>CBBD</b>	J; K; C; D

### Standard

Standard		Series 1	
<b>Cavity</b>	T-11A	<b>Model Code</b>	<b>Adjustment Range</b>
<b>Nominal Capacity</b>	60 L/min.	<b>CBCB</b>	H; I; A; B
		<b>CBCY (2)</b>	H; I; A; B
		<b>CBCL</b>	J; K; C; D
		<b>CBCA(3)</b>	H; I; A; B
		<b>CBCG (3)</b>	J; K; C; D
		<b>CBCH (4)</b>	J; K; C; D

## COUNTERBALANCE CARTRIDGE VALVES / VENTED

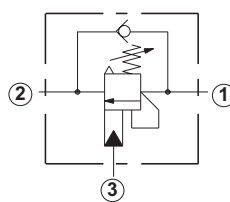

### Standard

Standard		Series 1	
<b>Cavity</b>	T-11A	<b>Model Code</b>	<b>Adjustment Range</b>
<b>Nominal Capacity</b>	60 L/min.	<b>CACK</b>	H; I
		<b>CACL</b>	F; G
		<b>CACA</b>	H; I
		<b>CACG</b>	F; G

### Standard

Standard		Series 1	
<b>Cavity</b>	T-21A	<b>Model Code</b>	<b>Adjustment Range</b>
<b>Nominal Capacity</b>	60 L/min.	<b>CWCK</b>	H; I
		<b>CWCL</b>	F; G
		<b>CWCA</b>	H; I
		<b>CWCG</b>	F; G

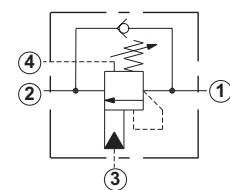

Visit [www.sunhydraulics.com](http://www.sunhydraulics.com) for current list pricing and complete technical information on all Sun products.



Series 2		Series 3		Series 4		Pilot Ratio	Max. Setting Depends on Pressure Range	Influence of Back Pressure			
T-2A		T-17A		T-19A					1.5:1	280 bar	2.5
20 L/min.		40 L/min.		80 L/min.					3:1	280 bar	4
4.5:1		350 bar		5.5							

Series 2		Series 3		Series 4		Pilot Ratio	Max. Setting Depends on Pressure Range	Influence of Back Pressure			
T-2A		T-17A		T-19A					2:1	280 bar	3
20 L/min.		40 L/min.		80 L/min.					3:1	280 bar	4
4.5:1		350 bar		5.5							

Series 2		Series 3		Series 4		Pilot Ratio	Max. Setting Depends on Pressure Range	Influence of Back Pressure			
T-2A		T-2A		T-19A					1.5:1	280 bar	2.5
80 L/min.		160 L/min.		480 L/min.					2.3:1	350 bar	3.3
4.5:1		350 bar		5.5							

Series 2		Series 3		Series 4		Pilot Ratio	Max. Setting Depends on Pressure Range	Influence of Back Pressure			
T-2A		T-17A		T-19A					1.5:1	280 bar	2.5
120 L/min.		240 L/min.		480 L/min.					2:1	280 bar	3
4.5:1		350 bar		5.5							

Series 2		Series 3		Series 4		Pilot Ratio	Max. Setting Depends on Pressure Range	Influence of Back Pressure			
T-2A		T-17A		T-19A					1:1	280 bar	0
120 L/min.		240 L/min.		480 L/min.					2:1	420 bar	0
4.5:1		350 bar		5.5							

Series 1		Series 3		Series 4		Pilot Ratio	Max. Setting Depends on Pressure Range	Influence of Back Pressure			
T-22A		T-23A		T-24A					1:1	280 bar	0
120 L/min.		240 L/min.		480 L/min.					2:1	420 bar	0
4.5:1		350 bar		5.5							

Visit [www.sunhydraulics.com](http://www.sunhydraulics.com) for current list pricing and complete technical information on all Sun products.



## Counterbalance Valves

# NON-VENTED, STANDARD, 280 BAR MAXIMUM SETTING, 3:1, 1.5:1, 2:1 PILOT RATIOS

Turn screw clockwise to reduce setting and release load.  
Complete Adjustment 3 3/4 Turns

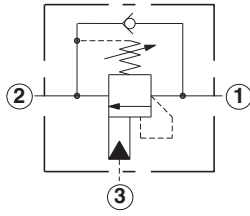
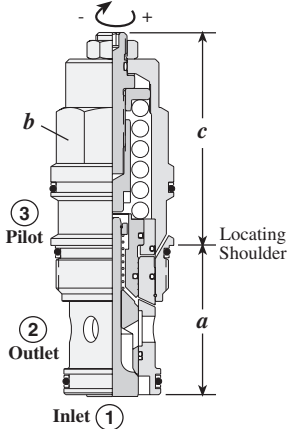

Capacity	Typical Cartridge Model Code	Cavity	Cartridge Dimensions				Installation Torque (Nm)
			a	b	L	C	
60 L/min.	<b>CBCA</b> - LHN	T - 11A	35,1	22,2	49,8	58,2	45 - 50
120 L/min.	<b>CBEA</b> - LHN	T - 2A	35,1	28,6	60,5	63,5	60 - 70
240 L/min.	<b>CBGA</b> - LHN	T - 17A	46,0	31,8	69,9	84,1	200 - 215
480 L/min.	<b>CBIA</b> - LHN	T - 19A	63,5	41,3	89,9	103,9	465 - 500

### Performance Curves

#### CBC\*

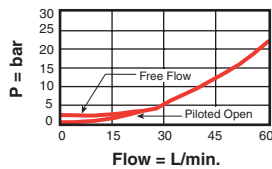

#### CBE\*

#### Free Flow and Piloted Open Pressure Drop

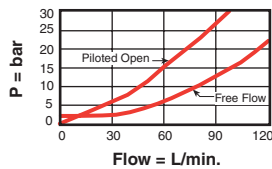

#### CBG\*

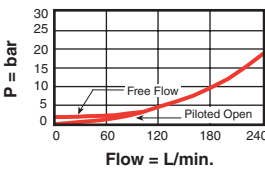

#### CBi\*

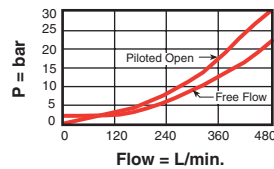

- Maximum recommended load pressure at maximum setting = 215 bar.
- Maximum setting = 280 bar.
- Maximum valve leakage at reseal = 0,4 cc/mm.
- Factory pressure setting established at 30 cc/min.
- Reseat exceeds 85% of set pressure when valve is standard set. Settings lower than the standard pressure may result in lower reseal percentage.
- Counterbalance valves should be set at least 1.3 times the maximum load induced pressure.
- Back pressure at port 2 adds to the effective relief setting at a ratio of 1 plus the pilot ratio times the back pressure.
- Two check valve cracking pressures are available. Use the 1,7 bar check unless actuator cavitation is a concern.

### OPTION ORDERING INFORMATION

CB**		***		
Nominal Capacity	Version	Control**	Functional Setting Range	Seal Material
<b>C</b> 60 L/min.	<b>A</b> 3:1 Pilot Ratio	<b>L</b> Standard Screw Adjustment	<b>H</b> 70 - 280 bar with 1,7 bar check Standard set at 210 bar	<b>N</b> Buna-N
<b>E</b> 120 L/min.	<b>B</b> 1.5:1 Pilot Ratio (Sealed Pilot)	<b>C*</b> Tamper Resistant Factory Set	<b>I</b> 28 - 105 bar with 1,7 bar check Standard set at 70 bar	<b>V</b> Viton
<b>G</b> 240 L/min.	<b>Y</b> 2:1 Pilot Ratio (Bleed through Pilot)	<i>*Special setting required. Specify at time of order.</i>	<b>A</b> 70 - 280 bar with 0,3 bar check Standard set at 210 bar	<i>Consult the Sun website for our most recent and complete information on the full Corrosion Resistant line of products.</i>
<b>I</b> 480 L/min.		<i>** See page 178 for information on Control Options</i>	<b>B</b> 28 - 105 bar with 0,3 bar check Standard set at 70 bar	
		<i>Customer specified special setting stamped on hex.</i>		

Visit [www.sunhydraulics.com](http://www.sunhydraulics.com) for current list pricing and complete technical information on all Sun products.

## Counterbalance Valves

# NON-VENTED, STANDARD, 350 BAR MAXIMUM SETTING, 4.5:1, 10:1, 2.3:1 PILOT RATIOS

Turn screw clockwise to reduce setting and release load.  
Complete Adjustment 3 3/4 Turns

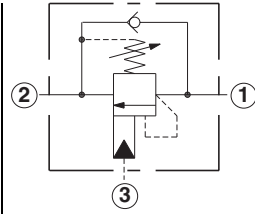
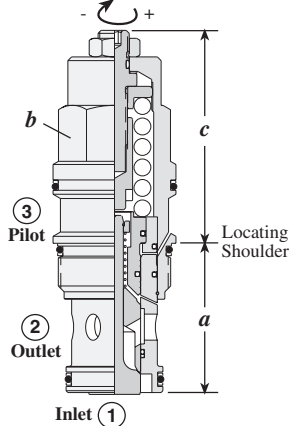

Capacity	Typical Cartridge Model Code	Cavity	Cartridge Dimensions				Installation Torque (Nm)
			a	b	L	C	
60 L/min.	CBG – L JN	T - 11A	35,1	22,2	50,0	58,2	45 - 50
120 L/min.	CBEG – L JN	T - 2A	35,1	28,6	60,5	63,5	60 - 70
240 L/min.	CBGG – L JN	T - 17A	46,0	31,8	69,9	84,1	200 - 215
480 L/min.	CBIG – L JN	T - 19A	63,5	41,3	89,9	103,9	465 - 500

### Performance Curves

#### CBC\*

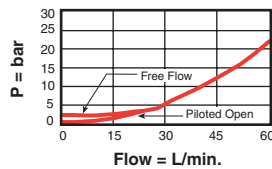

#### CBE\*

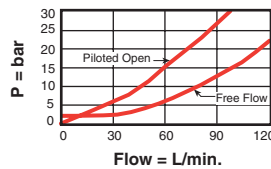

#### CBG\*

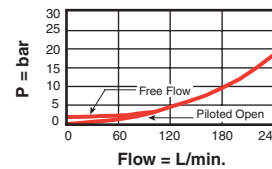

#### CB I\*

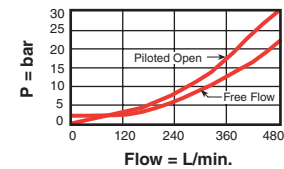

#### Free Flow and Piloted Open Pressure Drop

- Maximum recommended load pressure at maximum setting = 270 bar.
- Maximum setting = 350 bar.
- Maximum valve leakage at reseal = 0,4 cc/mm.
- Factory pressure setting established at 30 cc/min.
- Reseat exceeds 85% of set pressure when valve is standard set. Settings lower than the standard pressure may result in lower reseal percentage.
- Counterbalance valves should be set at least 1.3 times the maximum load induced pressure.
- Back pressure at port 2 adds to the effective relief setting at a ratio of 1 plus the pilot ratio times the back pressure.
- Two check valve cracking pressures are available. Use the 1,7 bar check unless actuator cavitation is a concern.

### OPTION ORDERING INFORMATION

Nominal Capacity	Version	Control**	Functional Setting Range	Seal Material
<b>C</b> 60 L/min.	<b>G</b> 4.5:1 Pilot Ratio	<b>L</b> Standard Screw Adjustment	<b>J</b> 140 - 350 bar with 1,7 bar check Standard set at 210 bar	<b>N</b> Buna-N
<b>E</b> 120 L/min.	<b>H</b> 10:1 Pilot Ratio	<b>C*</b> Tamper Resistant Factory Set	<b>K</b> 70 - 175 bar with 1,7 bar check Standard set at 140 bar	<b>V</b> Viton
<b>G</b> 240 L/min.	<b>L</b> 2.3:1 Pilot Ratio (Sealed Pilot)	<i>* Special setting required. Specify at time of order.</i>	<b>C</b> 140 - 350 bar with 0,3 bar check Standard set at 210 bar	
<b>I</b> 480 L/min.		<i>** See page 178 for information on Control Options</i>	<b>D</b> 70 - 175 bar with 0,3 bar check Standard set at 140 bar	

*Customer specified special setting stamped on hex.*

*Consult the Sun website for our most recent and complete information on the full Corrosion Resistant line of products.*

Visit [www.sunhydraulics.com](http://www.sunhydraulics.com) for current list pricing and complete technical information on all Sun products.

## Counterbalance Valves

# NON-VENTED, SEMI-RESTRICTIVE, 280 BAR MAXIMUM SETTING, 1.5:1, 3:1 PILOT RATIOS

Turn screw clockwise to reduce setting and release load.  
Complete Adjustment 3 3/4 Turns

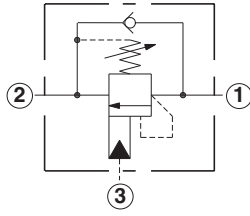
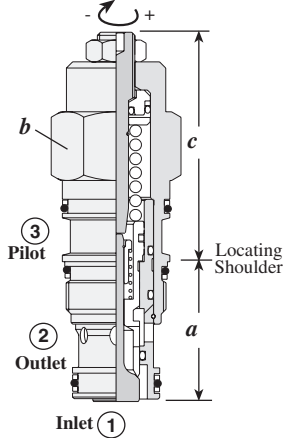

Capacity	Typical Cartridge Model Code	Cavity	Cartridge Dimensions				Installation Torque (Nm)
			a	b	L	C	
40 L/min.	CBBC - LHN	T - 11A	35,1	22,2	50,0	58,2	45 - 50
80 L/min.	CBDC - LHN	T - 2A	35,1	28,6	60,5	63,5	60 - 70
160 L/min.	CBFC - LHN	T - 17A	46,0	31,8	69,9	84,1	200 - 215

### Performance Curves

CBB\*

CBD\*

CBF\*

#### Free Flow and Piloted Open Pressure Drop

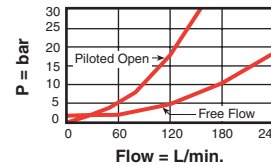
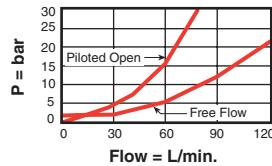
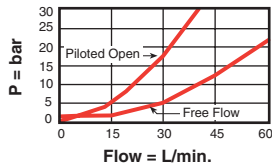

- Maximum recommended load pressure at maximum setting = 215 bar.
- Maximum setting = 280 bar.
- Maximum valve leakage at reseal = 0,4 cc/min.
- Factory pressure setting established at 30 cc/min.
- Reseat exceeds 85% of set pressure when the valve is standard set. Settings lower than the standard sets pressure may result in lower reseal percentages.
- Counterbalance valves should be set at least 1.3 times the maximum load induced pressure.
- Back pressure at port 2 adds to the effective relief setting at a ratio of 1 plus the pilot ratio times the back pressure.
- Two check valve cracking pressures are available. Use the 1,7 bar check unless actuator cavitation is a concern.

### OPTION ORDERING INFORMATION

Nominal Capacity	Version	Control**	Functional Setting Range	Seal Material
<b>B</b> 40 L/min.	<b>C</b> 3:1 Pilot Ratio (Sealed Pilot)	<b>L</b> Standard Screw Adjustment	<b>H</b> 70 - 280 bar with 1,7 bar check Standard set at 210 bar	<b>N</b> Buna-N
<b>D</b> 80 L/min.	<b>B</b> 1.5:1 Pilot Ratio (Sealed Pilot)	<b>C*</b> Tamper Resistant Factory Set	<b>I</b> 28 - 105 bar with 1,7 bar check Standard set at 70 bar	<b>V</b> Viton
<b>F</b> 160 L/min.		* Special setting required. Specify at time of order.	<b>A</b> 70 - 280 bar with 0,3 bar check Standard set at 210 bar	
		** See page 178 for information on Control Options	<b>B</b> 28 - 105 bar with 0,3 bar check Standard set at 70 bar	
		Customer specified special setting stamped on hex.		Consult the Sun website for our most recent and complete information on the full Corrosion Resistant line of products.

Visit [www.sunhydraulics.com](http://www.sunhydraulics.com) for current list pricing and complete technical information on all Sun products.

## Counterbalance Valves

# NON-VENTED, SEMI-RESTRICTIVE, 350 BAR MAXIMUM SETTING, 4.5:1, 2.3:1 PILOT RATIOS

Turn screw clockwise to reduce setting and release load.  
Complete Adjustment 3 3/4 Turns

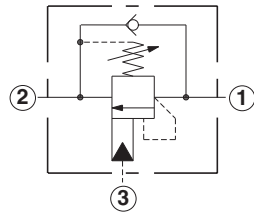
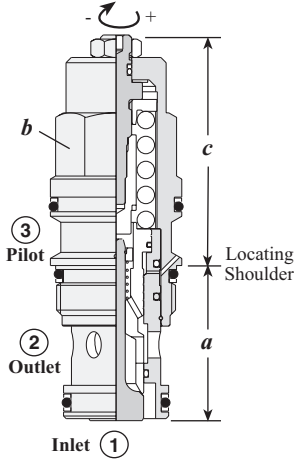

Capacity	Typical Cartridge Model Code	Cavity	Cartridge Dimensions				Installation Torque (Nm)
			a	b	L	C	
40 L/min.	CBBD – LJN	T - 11A	35,1	22,2	49,8	58,2	45 - 50
80 L/min.	CBDD – LJN	T - 2A	35,1	28,6	60,5	63,5	60 - 70
160 L/min.	CBFD – LJN	T - 17A	46,0	31,8	69,9	84,1	200 - 215

### Performance Curves

#### CBB\*

#### CBD\*

#### CBF\*

#### Free Flow and Piloted Open Pressure Drop

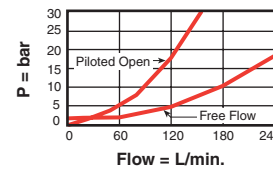
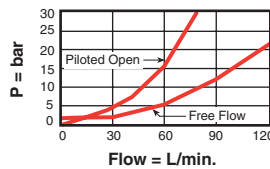
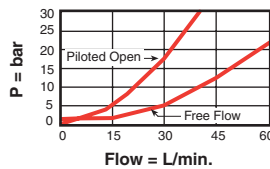

- Maximum recommended load pressure at maximum setting = 270 bar.
- Maximum setting = 350 bar.
- Maximum valve leakage at reseal = 0,4 cc/min.
- Factory pressure setting established at 30 cc/min.
- Reseat exceeds 85% of set pressure when valve is standard set. Settings lower than the standard pressure may result in lower reseal percentage.
- Counterbalance valves should be set at least 1.3 times the maximum load induced pressure.
- Back pressure at port 2 adds to the effective relief setting at a ratio of 1 plus the pilot ratio times the back pressure.
- Two check valve cracking pressures are available. Use the 1,7 bar check unless actuator cavitation is a concern.

### OPTION ORDERING INFORMATION

Nominal Capacity	Version	Control**	Functional Setting Range	Seal Material
<b>B</b> 40 L/min.	<b>D</b> 4.5:1 Pilot Ratio (Sealed Pilot)	<b>L</b> Standard Screw Adjustment	<b>J</b> 140 - 350 bar with 1,7 bar check Standard set at 210 bar	<b>N</b> Buna-N
<b>D</b> 80 L/min.	<b>L</b> 2.3:1 Pilot Ratio (Sealed Pilot)	<b>C*</b> Tamper Resistant Factory Set	<b>K</b> 70 - 175 bar with 1,7 bar check Standard set at 140 bar	<b>V</b> Viton
<b>F</b> 160 L/min.		<b>*</b> Special setting required. Specify at time of order.	<b>C</b> 140 - 350 bar with 0,3 bar check Standard set at 210 bar	
		<b>**</b> See page 178 for information on Control Options	<b>D</b> 70 - 175 bar with 0,3 bar check Standard set at 140 bar	
		<b>Customer specified special setting stamped on hex.</b>		Consult the Sun website for our most recent and complete information on the full Corrosion Resistant line of products.

Visit [www.sunhydraulics.com](http://www.sunhydraulics.com) for current list pricing and complete technical information on all Sun products.

## Counterbalance Valves

### NON-VENTED, RESTRICTIVE, 280 BAR MAXIMUM SETTING, 3:1, 2:1 PILOT RATIOS

Turn screw clockwise to reduce setting and release load.  
Complete Adjustment 3 3/4 Turns

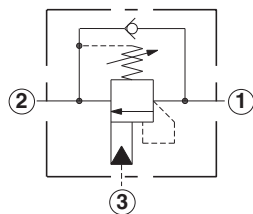
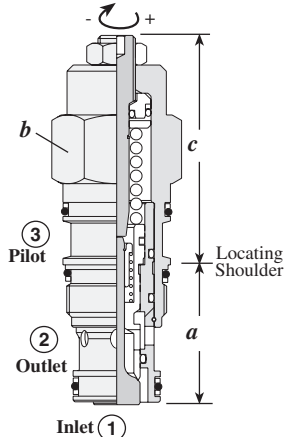

Capacity	Typical Cartridge Model Code	Cavity	Cartridge Dimensions				Installation Torque (Nm)
			a	b	L	C	
15 L/min.	CBBA - LHN	T - 11A	35,1	22,2	50,0	58,2	45 - 50
30 L/min.	CBDA - LHN	T - 2A	35,1	28,6	60,5	63,5	60 - 70
60 L/min.	CBFA - LHN	T - 17A	46,0	31,8	69,9	84,1	200 - 215
80 L/min.	CBHA - LHN	T - 19A	63,5	41,3	89,9	103,9	465 - 500

#### Performance Curves

CBB\*

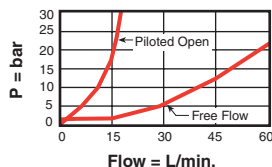

CBD\*

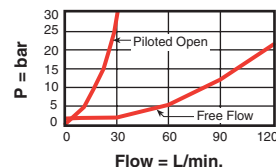

CBF\*

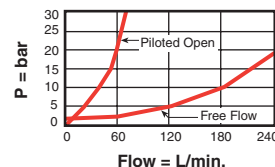

CBH\*

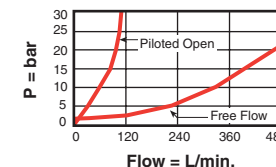

Free Flow and Piloted Open Pressure Drop

- Maximum recommended load pressure at maximum setting = 215 bar.
- Maximum setting = 280 bar.
- Maximum valve leakage at reseal = 0,4 cc/min.
- Factory pressure setting established at 30 cc/min.
- Reseat exceeds 85% of set pressure when valve is standard set. Settings lower than the standard pressure may result in lower reseal percentage.
- Counterbalance valves should be set at least 1.3 times the maximum load induced pressure.
- Back pressure at port 2 adds to the effective relief setting at a ratio of 1 plus the pilot ratio times the back pressure.
- Restrictive valves have no relief capacity other than as a thermal relief.
- Two check valve cracking pressures are available. Use the 1,7 bar check unless actuator cavitation is a concern.

#### OPTION ORDERING INFORMATION

Nominal Capacity	Version	Control**	Functional Setting Range	Seal Material
B 15 L/min.	A 3:1 Pilot Ratio (Sealed Pilot)	L Standard Screw Adjustment	H 70 - 280 bar with 1,7 bar check Standard set at 210 bar	N Buna-N
D 30 L/min.		C* Tamper Resistant Factory Set	I 28 - 105 bar with 1,7 bar check Standard set at 70 bar	V Viton
F 60 L/min.	<b>CBBY only:</b>		A 70 - 280 bar with 0,3 bar check Standard set at 210 bar	
H 80 L/min.	Y 2:1 Pilot Ratio (Bleed through Pilot)		B 28 - 105 bar with 0,3 bar check Standard set at 70 bar	

\* *Special setting required. Specify at time of order.*

\*\* *See page 178 for information on Control Options*

*Customer specified special setting stamped on hex.*

Consult the Sun website for our most recent and complete information on the full Corrosion Resistant line of products.

Visit [www.sunhydraulics.com](http://www.sunhydraulics.com) for current list pricing and complete technical information on all Sun products.



## Counterbalance Valves

# NON-VENTED, RESTRICTIVE, 350 BAR MAXIMUM SETTING, 4.5:1 PILOT RATIO

Turn screw clockwise to reduce setting and release load.  
Complete Adjustment 3 3/4 Turns

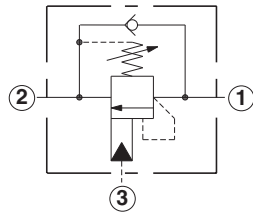
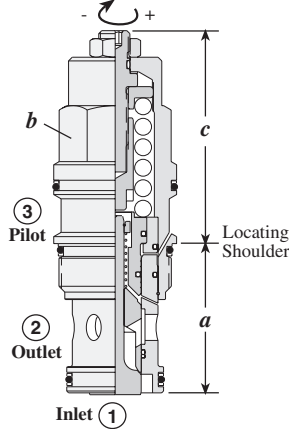

Capacity	Typical Cartridge Model Code	Cavity	Cartridge Dimensions				Installation Torque (Nm)
			a	b	L	C	
15 L/min.	<b>CBBG - LJN</b>	T - 11A	35,1	22,2	50,0	58,2	45 - 50
30 L/min.	<b>CBDG - LJN</b>	T - 2A	35,1	28,6	60,5	63,5	60 - 70
60 L/min.	<b>CBFG - LJN</b>	T - 17A	46,0	31,8	69,9	84,1	200 - 215
80 L/min.	<b>CBHG - LJN</b>	T - 19A	63,5	41,3	89,9	103,9	465 - 500

### Performance Curves

#### CBBG

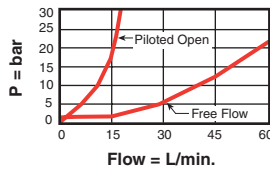

#### CBDG

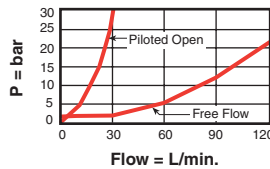

#### CBFG

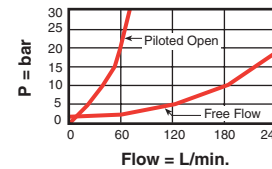

#### CBHG

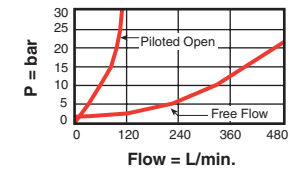

Free Flow and Piloted Open Pressure Drop

- Maximum recommended load pressure at maximum setting = 270 bar.
- Maximum setting = 350 bar.
- Maximum valve leakage at reseal = 0,4 cc/min.
- Factory pressure setting established at 30 cc/min.
- Reseat exceeds 85% of set pressure when valve is standard set. Settings lower than the standard pressure may result in lower reseal percentage.
- Counterbalance valves should be set at least 1.3 times the maximum load induced pressure.
- Back pressure at port 2 adds to the effective relief setting at a ratio of 1 plus the pilot ratio times the back pressure.
- Restrictive valves have no relief capacity other than as a thermal relief.
- Two check valve cracking pressures are available. Use the 1,7 bar check unless actuator cavitation is a concern.

### OPTION ORDERING INFORMATION

Nominal Capacity	Version	Control**	Functional Setting Range	Seal Material
<b>B</b> 15 L/min.	<b>G</b> 4.5:1 Pilot Ratio (Sealed Pilot)	<b>L</b> Standard Screw Adjustment	<b>J</b> 140 - 350 bar with 1,7 bar check Standard set at 210 bar	<b>N</b> Buna-N
<b>D</b> 30 L/min.		<b>C*</b> Tamper Resistant Factory Set		<b>V</b> Viton
<b>F</b> 60 L/min.		<b>*</b> Special setting required. Specify at time of order.	<b>K</b> 70 - 175 bar with 1,7 bar check Standard set at 140 bar	
<b>H</b> 80 L/min.		<b>**</b> See page 178 for information on Control Options	<b>C</b> 140 - 350 bar with 0,3 bar check Standard set at 210 bar	
		<b>Customer specified special setting stamped on hex.</b>	<b>D</b> 70 - 175 bar with 0,3 bar check Standard set at 140 bar	Consult the Sun website for our most recent and complete information on the full Corrosion Resistant line of products.

Visit [www.sunhydraulics.com](http://www.sunhydraulics.com) for current list pricing and complete technical information on all Sun products.

# Counterbalance Valves

## VENTED, ATMOSPHERICALLY REFERENCED, 3:1, 5:1, 1:1, 2:1 PILOT RATIOS

Turn screw clockwise to reduce setting and release load. Complete Adjustment 4 Turns

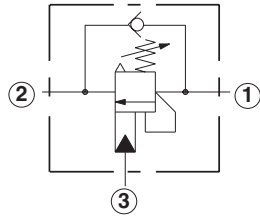
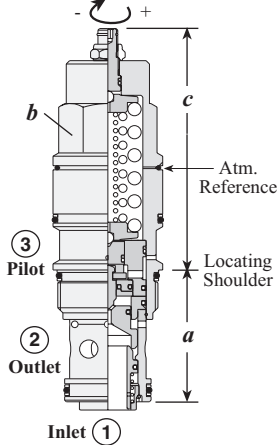

Capacity	Typical Cartridge Model Code	Cavity	Cartridge Dimensions				Installation Torque (Nm)
			a	b	L	C	
60 L/min.	CACA – LHN	T - 11A	35,1	22,2	73,4	82,6	45 - 50
120 L/min.	CAEA – LHN	T - 2A	35,1	28,6	83,6	89,9	60 - 70
240 L/min.	CAGA – LHN	T - 17A	46,0	31,8	95,0	100,8	200 - 215
480 L/min.	CAIA – LHN	T - 19A	63,5	41,3	116,3	126,0	465 - 500

### Performance Curves

CAC\*

CAE\*

CAG\*

CAI\*

Free Flow and Piloted Open Pressure Drop

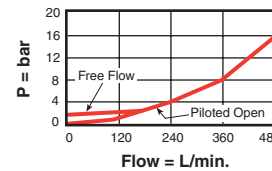
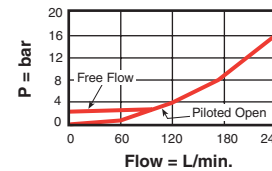
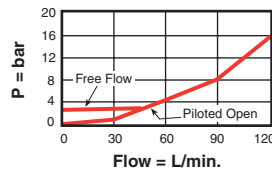
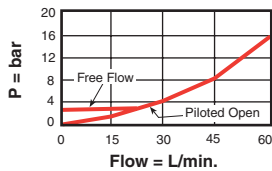

- Maximum recommended load pressure at maximum setting = CA\*A, CA\*K: 215 bar, CA\*G, CA\*L: 320 bar.
- Maximum setting = CA\*A, CA\*K: 280 bar, CA\*G, CA\*L: 420 bar.
- Maximum valve leakage at reseal = 0,4 cc/min.
- Reverse flow check cracking pressure = CAC\*: 2,8 bar, CAE\*, CAG\*: 1,7 bar, CAI\*: 1,5 bar.
- Factory pressure setting established at 30 cc/min.
- Reseat exceeds 85% of set pressure when the valve is standard set. Settings lower than the standards set pressure may result in lower reseats percentages.
- Counterbalance valves should be set at least 1.3 times the maximum load induced pressure.
- Approximately 1 drop of fluid will pass from the pilot area to the vented spring chamber every 4000 cycles.

### OPTION ORDERING INFORMATION

Nominal Capacity	Version	Control**	Functional Setting Range	Seal Material
C 60 L/min.	A 3:1 Pilot Ratio	L Standard Screw Adjustment	CA*A, CA*K, only:	N Buna-N
E 120 L/min.	G 5:1 Pilot Ratio	C* Tamper Resistant Factory Set	H 70 - 280 bar Standard set at 210 bar	V Viton
G 240 L/min.	K 1:1 Pilot Ratio		I 28 - 105 bar Standard set at 70 bar	
I 480 L/min.	L 2:1 Pilot Ratio		CA*G, CA*L only:	
			F 70 - 175 bar Standard set at 140 bar	
			G 140 - 420 bar Standard set at 280 bar	

\*\* See page 178 for information on Control Options

Customer specified special setting stamped on hex.

CA\*A, CA\*K, CA\*G, CA\*L:  
Patent: U.S. #4,834,135

Visit [www.sunhydraulics.com](http://www.sunhydraulics.com) for current list pricing and complete technical information on all Sun products.



# Counterbalance Valves

## VENTED, 280 BAR MAXIMUM SETTING, 3:1, 1:1 PILOT RATIOS

Turn screw clockwise to reduce setting and release load.  
Complete Adjustment 4 Turns

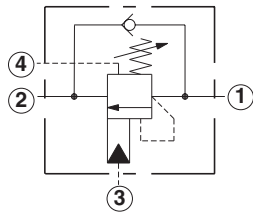
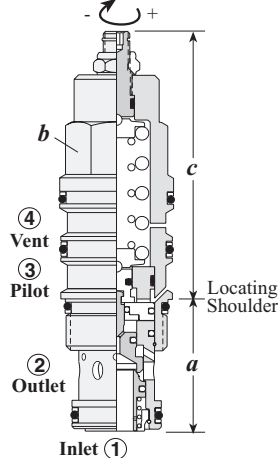

Capacity	Typical Cartridge Model Code	Cavity	Cartridge Dimensions				Installation Torque (Nm)
			a	b	L	C	
60 L/min.	<b>CWCA</b> - LHN	T - 21A	34,9	22,2	74,0	82,6	40 - 50
120 L/min.	<b>CWEA</b> - LHN	T - 22A	34,9	28,6	84,0	90,0	60 - 70
240 L/min.	<b>CWGA</b> - LHN	T - 23A	46,0	31,8	95,3	101,0	200 - 215
480 L/min.	<b>CWIA</b> - LHN	T - 24A	63,5	41,3	117,0	126,0	465 - 500

### Performance Curves

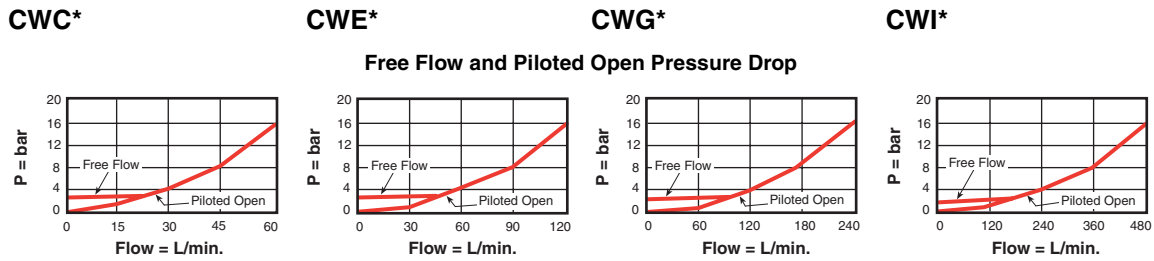

- Maximum recommended load pressure at maximum setting = 215 bar.
- Maximum setting = 280 bar.
- Maximum valve leakage at reseal = 0,4 cc/min.
- Reverse flow check cracking pressure = CWC\*: 2,8 bar, CWE\*, CWG\*: 1,7 bar, CWI\*: 1,5 bar.
- Factory pressure setting established at 30 cc/min.
- Reseat exceeds 85% of set pressure when the valve is standard set. Settings lower than the standards set pressure may result in lower reseats percentages.
- Counterbalance valves should be set at least 1.3 times the maximum load induced pressure.

### OPTION ORDERING INFORMATION

**CW\*\***

Nominal Capacity	Version	Control**	Functional Setting Range	Seal Material
<b>C</b> 60 L/min.	<b>A</b> 3:1 Pilot Ratio	<b>L</b> Standard Screw Adjustment	<b>H</b> 70 - 280 bar Standard set at 210 bar	<b>N</b> Buna-N
<b>E</b> 120 L/min.	<b>K</b> 1:1 Pilot Ratio	<b>C*</b> Tamper Resistant Factory Set	<b>I</b> 28 - 105 bar Standard set at 70 bar	<b>V</b> Viton

\* Special setting required. Specify at time of order.

\*\* See page 178 for information on Control Options

Customer specified special setting stamped on hex.

Consult the Sun website for our most recent and complete information on the full Corrosion Resistant line of products.

CW\*A, CW\*K:  
Patent: U.S. #4,834,135

Visit [www.sunhydraulics.com](http://www.sunhydraulics.com) for current list pricing and complete technical information on all Sun products.



# Counterbalance Valves

## VENTED, 420 BAR MAXIMUM SETTING, 5:1, 2:1 PILOT RATIOS

Turn screw clockwise to reduce setting and release load. Complete Adjustment 4 Turns

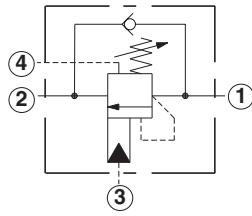
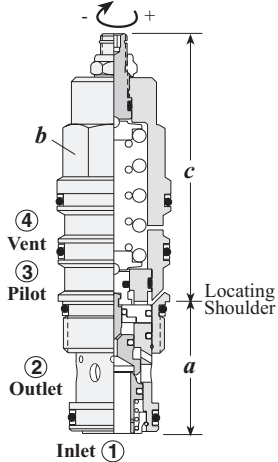

Capacity	Typical Cartridge Model Code	Cavity	Cartridge Dimensions				Installation Torque (Nm)
			a	b	L	C	
60 L/min.	CWCG- LFN	T - 21A	35,0	22,2	74,0	82,6	40 - 50
120 L/min.	CWEG- LFN	T - 22A	35,0	28,6	83,6	90,0	60 - 70
240 L/min.	CWGG- LFN	T - 23A	46,0	31,8	93,3	101,0	200 - 215
480 L/min.	CWIG - LFN	T - 24A	63,5	41,3	117,0	126,0	465 - 500

### Performance Curves

CWC\*

CWE\*

CWG\*

CWI\*

Free Flow and Piloted Open Pressure Drop

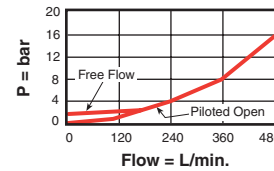
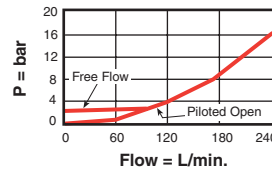
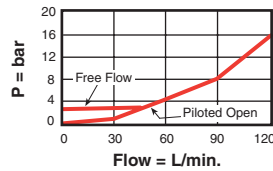
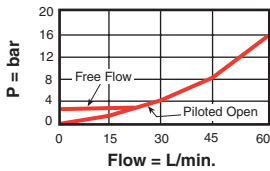

- Maximum recommended load pressure at maximum setting = 320 bar.
- Maximum setting = 420 bar.
- Maximum valve leakage at reseal = 0,4 cc/min.
- Reverse flow check cracking pressure = CWC\*: 2,8 bar, CWE\*, CWG\*: 1,7 bar, CWI\*: 1,5 bar.
- Factory pressure setting established at 30 cc/min.
- Reseat exceeds 85% of set pressure when the valve is standard set. Settings lower than the standards set pressure may result in lower reseats percentages.
- Counterbalance valves should be set at least 1.3 times the maximum load induced pressure.

### OPTION ORDERING INFORMATION

**CW\*\* - \*\*\***

Nominal Capacity	Version	Control**	Functional Setting Range	Seal Material
<b>C</b> 60 L/min.	<b>G</b> 5:1 Pilot Ratio	<b>L</b> Standard Screw Adjustment	<b>F</b> 70 - 175 bar Standard set at 140 bar	<b>N</b> Buna-N
<b>E</b> 120 L/min.	<b>L</b> 2:1 Pilot Ratio	<b>C*</b> Tamper Resistant Factory Set	<b>G</b> 140 - 420 bar Standard set at 280 bar	<b>V</b> Viton
<b>G</b> 240 L/min.				
<b>I</b> 480 L/min.				

\* Special setting required. Specify at time of order.

\*\* See page 178 for information on Control Options

Customer specified special setting stamped on hex.

Consult the Sun website for our most recent and complete information on the full Corrosion Resistant line of products.

CW\*G, CW\*L:  
Patent: U.S. #4,834,135

Visit [www.sunhydraulics.com](http://www.sunhydraulics.com) for current list pricing and complete technical information on all Sun products.