

Free Flow Check Valves

FREE FLOW NOSE TO SIDE

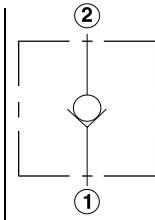
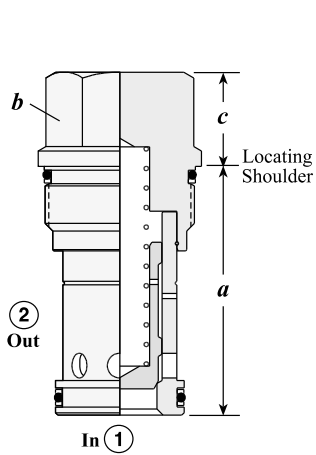

Capacity	Typical Cartridge Model Code	Cavity	Cartridge Dimensions			Installation Torque (Nm)
			a	b	c	
40 L/min.	CXBA - XCN	T - 162A	31	19,1	21	35/40
80 L/min.	CXDA - XCN	T - 13A	34,9	22,2	19	40/50
160 L/min.	CXFA - XCN	T - 5A	41,1	28,6	18	60/70
320 L/min.	CXHA - XCN	T - 16A	61,9	31,8	25	200/215
640 L/min.	CXJA - XCN	T - 18A	79,4	41,3	31	465/500

Performance Curves

CXBA

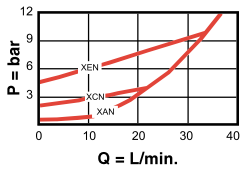

CXDA

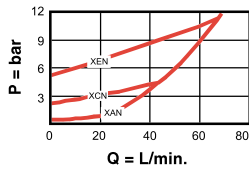

CXFA

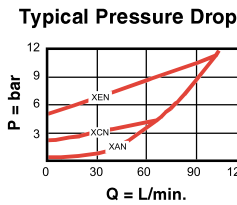

CXHA

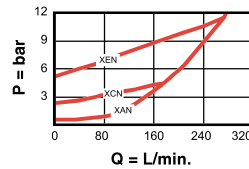

CXJA

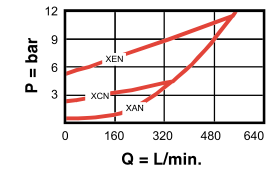

- Maximum operating pressure = 350 bar
- Maximum valve leakage = 0,07 cc/min.
- Will accept 350 bar at ports 1 and 2.

OPTION ORDERING INFORMATION **Model Codes printed in Red are Preferred Versions and most readily available**

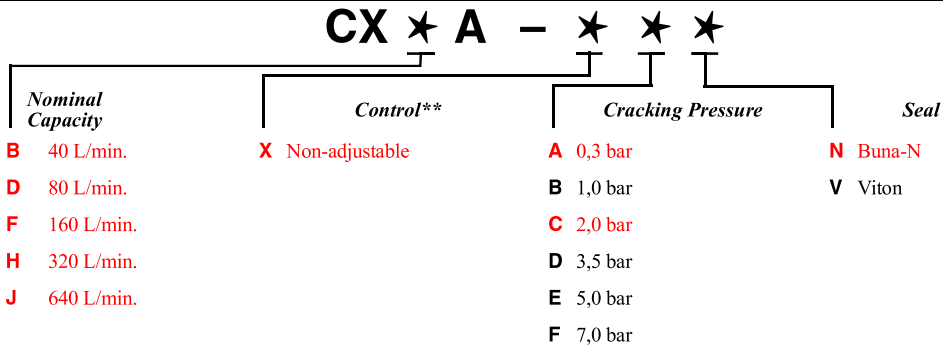

** See page 162 for information on Control Options

Visit www.sunhydraulics.com for detailed and complete technical information on our full line of products.