

2-WAY SLIP-IN CARTRIDGE VALVES DIRECTIONAL AND PRESSURE FUNCTION ISO 7368 SIZES 16 TO 100



Rev. A, June 2013

FLOW-OPTIMIZED DESIGN FOR 420 BAR
(6,000 PSI) OPERATING PRESSURE AND
MAXIMUM ENERGY EFFICIENCY

Whenever the highest levels of motion control performance and design flexibility are required, you'll find Moog expertise at work. Through collaboration, creativity and world-class technological solutions, we help you overcome your toughest engineering obstacles. Enhance your machine's performance. And help take your thinking further than you ever thought possible.

INTRODUCTION.....	2
Product Overview	3
Description of Operation	4
Flow Calculation.....	9
Installation Instructions.....	10
TECHNICAL DATA	11
General Technical Data.....	11
Size 16	12
Size 25	16
Size 32	20
Size 40	24
Size 50	28
Size 63	32
Size 80	36
Size 100.....	40
Installation Dimensions.....	44
ORDERING INFORMATION.....	46
Accessories and Spare Parts.....	46
Removal Tools	52
About Moog.....	53
Ordering Code	55



This catalog is for users with technical knowledge. To ensure all necessary characteristics for function and safety of the system, the user has to check the suitability of the products described herein. The products described herein are subject to change without notice. In case of doubt, please contact Moog.

Moog is a registered trademark of Moog Inc. and its subsidiaries. All trademarks as indicated herein are the property of Moog Inc. and its subsidiaries. For the full disclaimer refer to www.moog.com/literature/disclaimers.

For the most current information, visit www.moog.com/industrial or contact your local Moog office.

PRODUCT OVERVIEW

2-way Slip-in Cartridge Valves are logic elements designed for use in hydraulic manifolds. With a compact design, this product series offers a high power density for high performance hydraulic systems. In addition to the slip-in cartridge valve, a cover and in most cases, a pilot valve are required for the valve to be fully functional.

The 2-way Slip-in Cartridge Valves featured in this catalog are designed for 420 bar (6,000 psi) operation and offer the highest nominal flows and lowest pressure drops available on the market. State-of-the-art development techniques were used to optimize the design, and increase the energy efficiency of the systems in which they are installed.

This series offers a variety of directional and pressure control functions. Versions are available for the nominal diameters (Sizes) 16, 25, 32, 40, 50, 63, 80 and 100 mm and each can be used with all the standard CCE covers (see cover catalog for more details). Designed in accordance with ISO 7368, these cartridge valves can be exchanged with other cartridge valves with the same functions.

Cartridge valves in the manifold

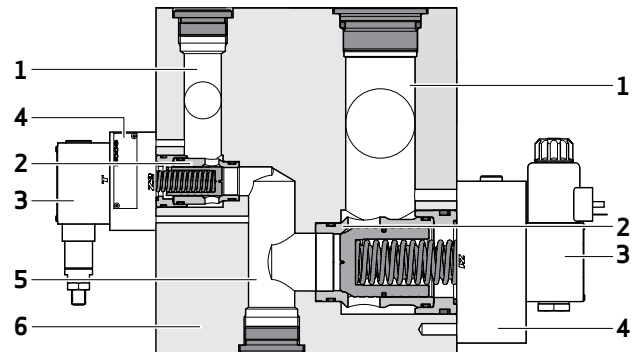

- 1 B port
- 2 Cartridge valve
- 3 Pilot valve
- 4 Cover
- 5 A port
- 6 Manifold

Features and Benefits

Feature	Advantage
Flow-optimized design with highest nominal flows and lowest pressure drops	Compact manifold design and minimal energy consumption, reduces operating costs
Robust design for a nominal pressure of 420 bar (6,000 psi)	Highest load capability, even in extreme environments applications
Directional and pressure control functions for all sizes with numerous options are available (e.g., damping noses, spring strengths, shaft seals)	Wide selection of functions for maximum flexibility in manifold design
Extremely reliable and durable design and construction	High degree of system availability
Optimized design of valve seat and shaft seal	Leakage free valve seat and stable behavior of pressure controls

DESCRIPTION OF OPERATION

Operating Principle for Directional Function

Whether an application requires a simple check (non-return) function or something much more complex, it is important to understand the basic operating principles of a directional cartridge valve in order to get the most performance out of the application.

A directional control function requires, first of all, a B, C, E or F poppet. These poppets, with a stepped shape, have 3 different control surfaces which is the key to their operation.

When used with a cartridge cover and corresponding pilot valve, the sum of the pressures applied to each of these control surfaces either opens or closes the cartridge valve. Surfaces A_A and A_B work to open the valve, while surface A_X together with the spring force work to close the valve.

When in the open position, the poppet enables fluid flow in both directions, from A to B or B to A depending on the needs of the application.

When the poppet is in the closed position, the valve seat design ensures a leak free separation of ports A and B.

Should a leak free separation of ports B and X also be desired, an optional shaft seal is available to seal the gap between poppet and sleeve.

The size of the valve, the strength of the spring, and the poppet type can be selected from the product code. There is also the option of using sandwich plate valves to enhance the functionality (for example slow opening, rapid closing) of the valve. Please refer to the relevant catalog for more information.

Control area ratios

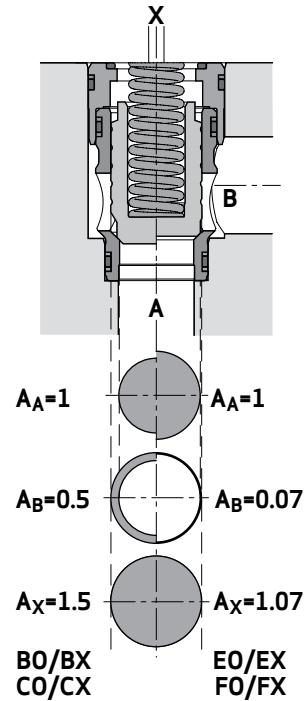

2-way Slip-in Cartridge Valve - Directional Function

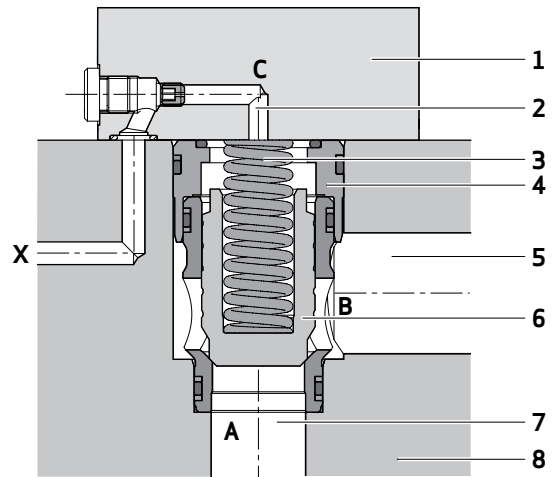

- | | | | |
|---|----------------|---|----------|
| 1 | Cover | 5 | B port |
| 2 | Control port C | 6 | Poppet |
| 3 | Spring | 7 | A port |
| 4 | Sleeve and cap | 8 | Manifold |

DESCRIPTION OF OPERATION

Operating Principle for Pressure Function

Pressure relief valves are a vital component of any hydraulic system. These valves are used to limit the maximum permissible hydraulic pressure at the relevant port. Typical applications include limiting pump and cylinder pressures. The limiting of cylinder pressures not only protects the cylinder from damage, but also enables the reliable control of the force applied by the cylinder.

Unlike directional valves, the A0 and EX poppets used in pressure valves have no or only a small control surface at port B. Leaving only 2 primary control surfaces, surface A working to open the valve, and surface X together with the spring force working to close the valve. In combination with a cover and a pilot valve, both manual and electrical proportional pressure settings can be realized with or without relief functionality. In order to get the most out of these functions, it is important to understand the basic operating principles of a pressure cartridge.

The pressure to be limited is applied to port A (9) and is also routed simultaneously to port C (4) of the cover (3) and the pilot valve (1) via a pilot line (11) equipped with a suitable metering orifice. If the pressure in port A acting on surface A_A exceeds the preset pressure setting of the pilot valve, the pilot valve opens venting the pressure at port C and therefore the pressure on A_X . The pressure compensated poppet (8) then opens against the spring force (5) and set pressure, limiting the pressure at port A. Please refer to the "Pressure Valves" catalog for detailed information regarding the pressure and flow characteristics of these valves.

When ordering a pressure cartridge, the valve size, spring strength and poppet design can be selected from the product code. It is also possible to enhance the functionality (for example a depressurizing function or additional pressure stages) by using additional sandwich plate valves.

For pressure reducing and compensating functions Moog offers the CKE range of 2-way Slip-in Cartridge Valves with a spool design. Please refer to the catalog for more information.

Control area ratios

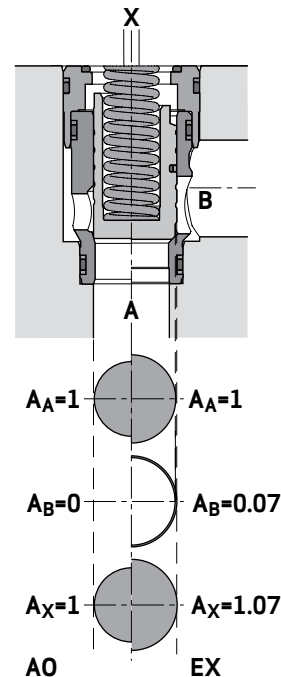

2-way Slip-in Cartridge Valve - Pressure Control

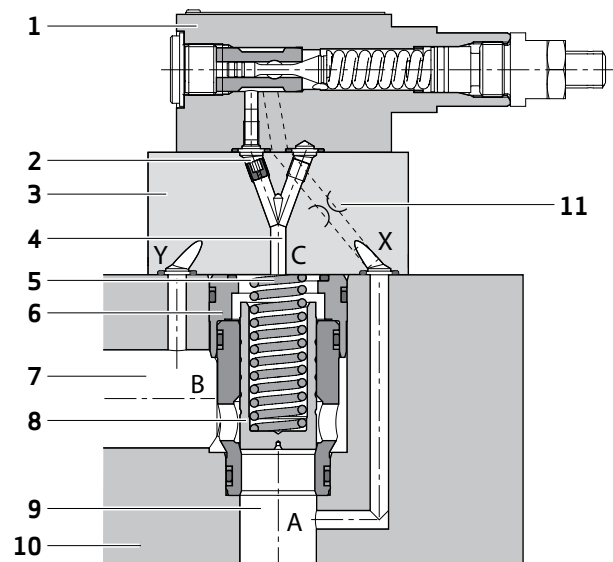

- | | | | |
|---|------------------------------|----|------------------------------|
| 1 | Pilot valve, pressure relief | 7 | B port |
| 2 | Damping orifice | 8 | Poppet |
| 3 | Cover | 9 | A port |
| 4 | C port | 10 | Manifold |
| 5 | Spring | 11 | X port with metering orifice |
| 6 | Sleeve and cap | | |

DESCRIPTION OF OPERATION

Directional Poppet Types - B and C Poppets (Control Area Ratio $A_A:A_X$ of 1:1.5)

4 poppet types (B, C, E and F) are available for directional control functions. This section will focus on 2 of these poppet types: The B and C poppets.

BO Poppet

The B poppet is the standard stepped poppet for directional control functions. The poppet has a control area ratio $A_A:A_X$ of 1:1.5 and the flow area is approximately proportional to the poppet stroke.

CO Poppet

The C poppet is based upon the B poppet and has the same control surface ratio. The only difference is that the C poppet is equipped with a damping nose. This damping nose enables a more gradual increase/decrease in flow during the lower part of the poppet stroke. This is useful in applications that require a damped switching function to prevent pressure spikes in the hydraulic system.

Optional Shaft Seal: BX and CX Poppet

Both, the B and the C poppets can be equipped with an optional shaft seal (denoted as a BX or CX poppet in the product code).

The shaft seal is important for applications where it is necessary to seal off port X from port B. To accomplish this, a shaft seal (1) is installed on the outer diameter of the poppet creating a leak free seal between the poppet and the cartridge sleeve.

When using a cartridge valve with a shaft seal, Moog recommends using the strongest spring available to ensure a secure closing of the valve against the friction force of the shaft seal.

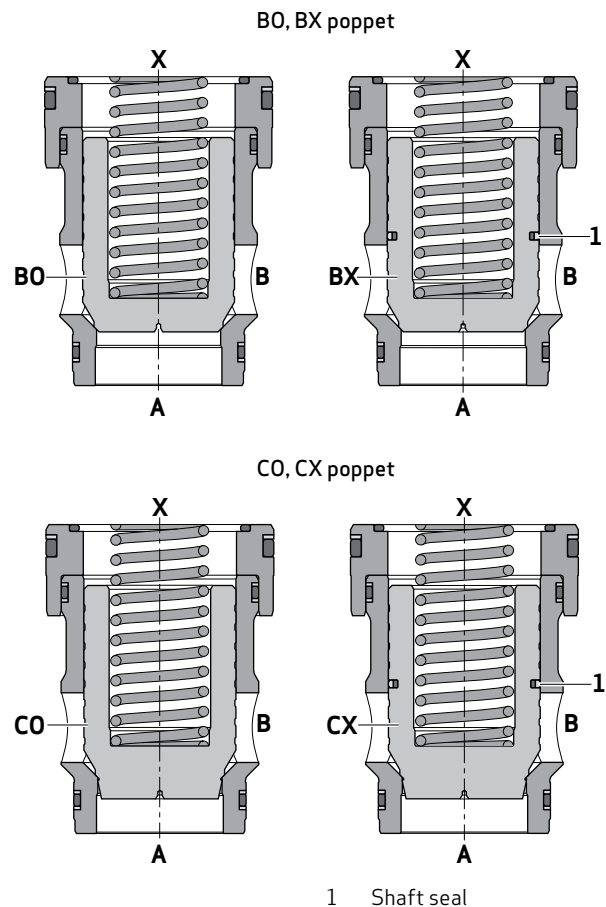

DESCRIPTION OF OPERATION

Directional Poppet Types - E and F Poppets (Control Area Ratio $A_A:A_X$ of 1:1.07)

4 poppet types (B, C, E and F) are available for directional control functions. This section will focus on 2 of these poppet types: The E and F poppets.

EO Poppet

The E poppet is available for directional control applications where a smaller control surface in port B and a larger control surface in port A is desired. The poppet has a control area ratio $A_A:A_X$ of 1:1.07 and the flow area is approximately proportional to the poppet stroke.

FO Poppet

The F poppet is based upon the E poppet and has the same control surface ratio. The only difference is that the F poppet is equipped with a damping nose. This damping nose enables a more gradual increase/decrease in flow during the lower part of the poppet stroke. This is useful in applications that require a damped switching function to prevent pressure spikes in the hydraulic system.

Optional Shaft Seal: EX and FX Poppet

Both the E and the F poppets can be equipped with an optional shaft seal (denoted as an EX or FX poppet in the product code).

The shaft seal is important for applications where it is necessary to seal off port X from port B. To accomplish this, a shaft seal (1) is installed on the outer diameter of the poppet creating a leak free seal between the poppet and the cartridge sleeve.

When using a cartridge valve with a shaft seal, Moog recommends also using the strongest spring available to ensure a secure closing of the valve against the friction force of the shaft seal.

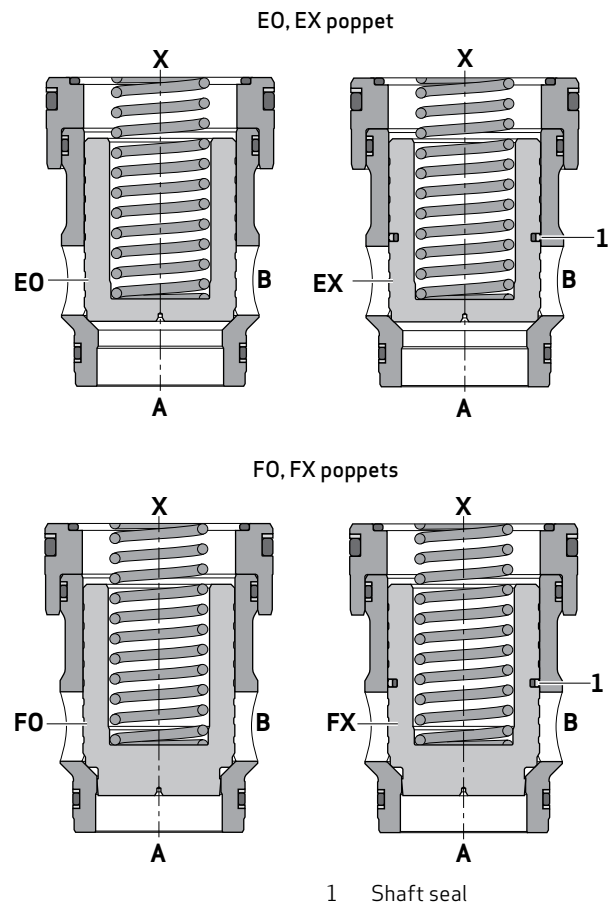

DESCRIPTION OF OPERATION

Pressure Poppet Types - AO and EX Poppets

AO and EX Poppets

2 poppets are available for pressure relief function: The AO and EX poppets.

AO Poppet (without shaft seal)

The AO poppet is designed for conventional pressure relief functions. Due to the fact that the poppet has no control surface in port B, the control area ratio is $A_A:A_X = 1:1$. Please note, for a pressure relief function it is important that the pressure in port X not greatly exceeds the pressure in port A, otherwise damage to the valve seat may occur.

EX Poppet (with shaft seal)

The EX poppet, with its shaft seal and a control area ratio of $A_A:A_X = 1:1.07$, is ideal for pressure relief applications where it is necessary to seal off port X from port B. The shaft seal (1) installed on the outer diameter of the poppet, creates a leak-free seal between the poppet and the cartridge sleeve.

When using a cartridge valve with a shaft seal, Moog recommends using the strongest spring available to ensure a secure closing of the valve against the friction force of the shaft seal.

Optional Internal Pilot Oil Supply

Both the A and E poppets can be ordered with a metric thread in the bottom of the poppet to accommodate an orifice (2). This orifice enables an internal pilot oil supply from port A to port X. Please see the „Ordering Information“ for the full range of orifice options.

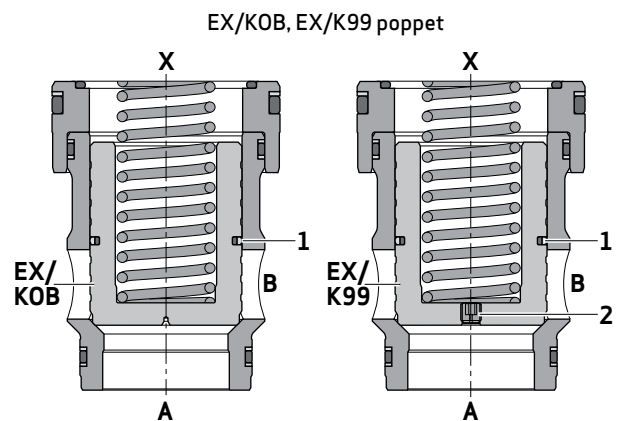
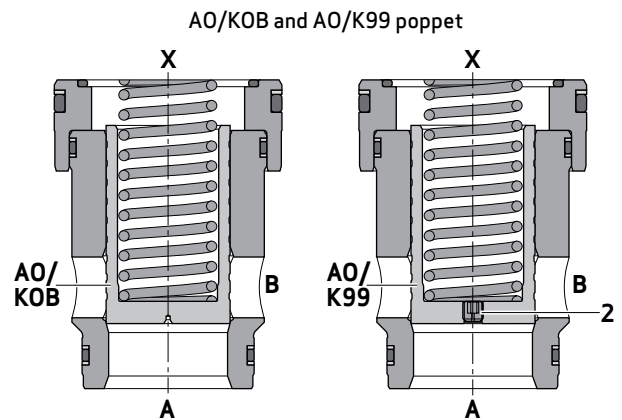

- 1 Shaft seal
- 2 Threaded bore in poppet

FLOW CALCULATION

Performance curves similar to those below showing the pressure loss in relation to the flow rate can be found for each of the cartridge sizes and poppet types in the corresponding sections of this catalog.

Should your application require a flow rate beyond the range of these curves, it is possible to use the following equation to approximate that flow (Q, Δp) by using a known reference point (Q_N, Δp_N) on the curve.

In order to prevent cavitation damage from occurring, the flow should not exceed a mean velocity of 30 m/s (approximately 100 ft/s) in the valve manifold ports. The flow rate that corresponds to this maximum recommended flow velocity can be found in the individual flow curves for the different valve sizes.

$$Q = Q_N \cdot \sqrt{\frac{\Delta p}{\Delta p_N}}$$

- Q [l/min (gpm)] flow to be calculated
- Q_N [l/min (gpm)] known nominal flow from curve
- Δp [bar (psi)] pressure loss at the flow rate to be calculated
- Δp_N [bar (psi)] known pressure loss at nominal flow curve

Use Recommendations

The following recommendations can help further reduce the pressure loss and maximize the performance of your Moog Slip-in Cartridge Valve:

Flow direction

A flow from A to B is preferable when trying to reduce pressure losses. Detailed flow curves for both flow directions can be found in the flow diagrams for each valve size and poppet type.

B Port diameter

Drilling the downstream B port larger than the ISO 7368 recommended diameter will help reduce pressure losses. For maximum permissible B port diameters, please refer to the "Installation Dimensions" section in this catalog.

Cartridge orientation

When installing the cartridge valve in the manifold, proper alignment of the cartridge valve will further reduce the pressure losses of the valve. Please see the "Installation Instructions" for further information.

Sizes 16 to 40

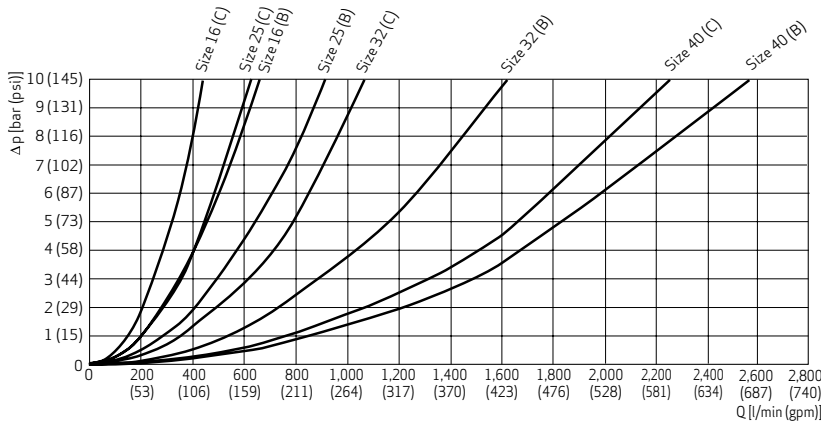

- (B) BO/BX poppet
- (C) CO/CX poppet

Sizes 50 to 100

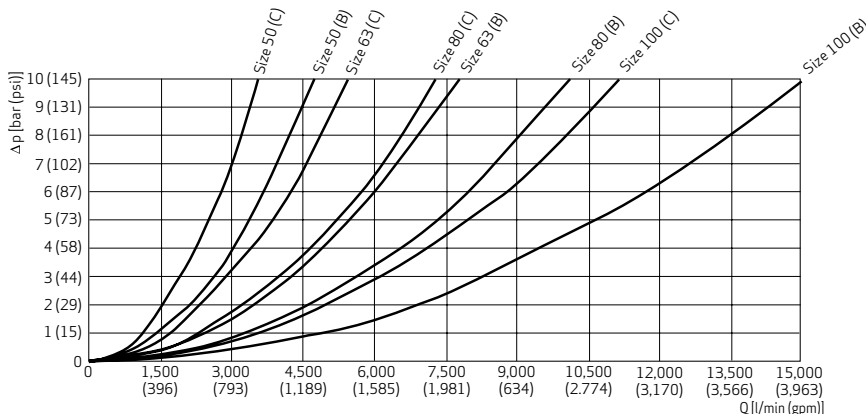

- (B) BO/BX poppet
- (C) CO/CX poppet

INSTALLATION INSTRUCTIONS

The following instructions will ensure the correct installation and maximum performance of the 2-way Slip-in Cartridge Valve.

Seals

Check that all seals and back-up rings are mounted correctly. The back-up rings must not protrude beyond the outer diameter of the o-ring groove. If necessary, remove the back-up ring and "tighten" to a smaller diameter, then install the back-up ring again. Grease all outer seals slightly prior to installing the cartridge in the manifold cavity.

Cartridge Orientation

In order to fully utilize the flow-optimized design of the 2-way Slip-in Cartridge Valves, the valve must be properly aligned within the manifold cavity as follows:

- For valve sleeves with 6 lateral holes, the cartridge valve must be installed such that the "bridge" between two of the lateral holes is facing towards the B port of the manifold. In other words, the two lateral holes should align symmetrically, and not parallel, with the B port.
- For valve sleeves with 4 lateral holes (size 16 AO poppet only), the cartridge valve must be installed with one hole facing towards (parallel to) the B port of the manifold.

The diagram shows, as an example, the effect that proper cartridge orientation can have on the pressure loss of a valve with size 25.

Ideal cartridge orientation for sleeves with 6 holes

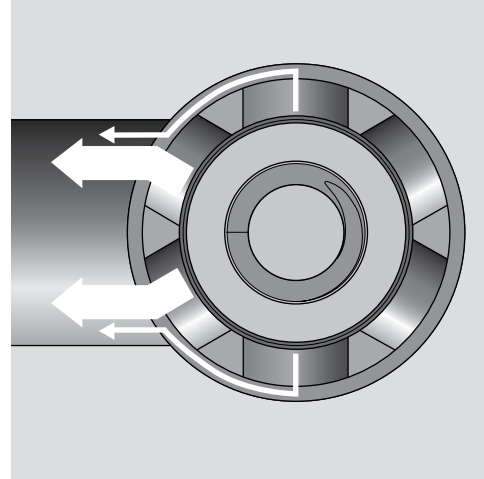

Ideal cartridge orientation for sleeves with 4 holes

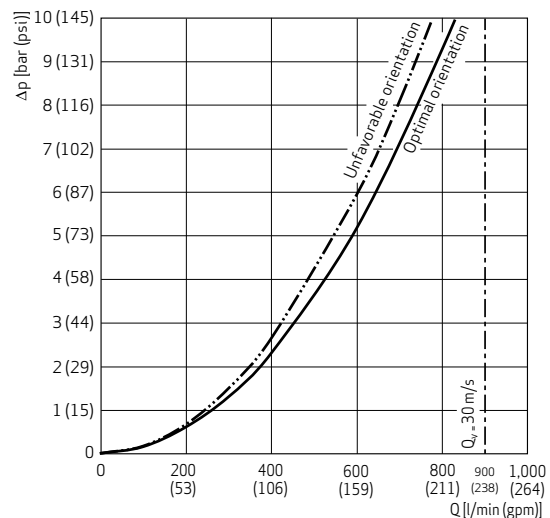
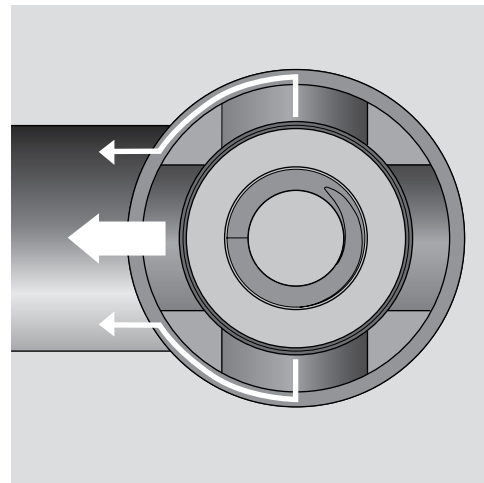

GENERAL TECHNICAL DATA

General Technical Data

Valve type	2-way Slip-in Cartridge Valve
Valve design	Seated valve
Mounting type	Manifold mounting
Flow direction	A ↔ B (A → B)
Installation position	Any
Mounting pattern	ISO 7368:1989-08
Storage temperature range	
Valve with FKM seals	-20 to +80 °C (-4 to 176 °F)
Valve with NBR seals	-30 to +80 °C (-22 to 176 °F)
Ambient temperature range	
Valve with FKM seals	-20 to +80 °C (-4 to 176 °F)
Valve with NBR seals	-30 to +80 °C (-22 to 176 °F)
MTTFd value according to EN ISO 13849-1	150 years

Hydraulic Data

Maximum operating pressure port A, B, X ¹⁾	420 bar (6,000 psi)
Seal material/hydraulic fluid combination	
FKM	<ul style="list-style-type: none"> • Mineral oil based hydraulic fluids • HFD hydraulic fluids
NBR	<ul style="list-style-type: none"> • Mineral oil based hydraulic fluids • HFB, HFC hydraulic fluids
Temperature range of hydraulic fluid	
Valve with FKM seals	-20 to +80 °C (-4 to 176 °F)
Valve with NBR seals	-30 to +80 °C (-22 to 176 °F)
Recommended viscosity range	15 to 46 mm ² /s (cSt)
Recommended viscosity range	15 to 46 mm ² /s (cSt)
Maximum permissible viscosity range	2.8 to 380 mm ² /s (cSt)
Recommended cleanliness class as per ISO 4406	
For functional safety	20/18/15
For longer service life	17/14/11

1) Please regard the maximum operating pressure of control cover and pilot valve.

SIZE 16 - DIRECTIONAL CONTROL

General Technical Data

Flow direction	A ↔ B
Mounting pattern	ISO 7368-BA-06-2-A
Weight	0.17 kg (0.4 lb)

Specific Hydraulic Data

With poppet type	BO/BX	CO/CX	EO/EX	FO/FX
Maximum operating pressure port A, B, X¹⁾	420 bar (6,000 psi)			
Pilot volume (area A_X)	2.83 cm ³ (0.17 in ³)			
Control panel				
Poppet stroke	9 mm (0.35 in)			
Surface A_A	209 mm ² (0.32 in ²)	290 mm ² (0.45 in ²)		
Factor A _A	1			
Factor A _B	0.5	0.07		
Factor A _X	1.5	1.07		
Seal material/hydraulic fluid combination				
FKM	<ul style="list-style-type: none"> Mineral oil based hydraulic fluids HFD hydraulic fluids 			
NBR	<ul style="list-style-type: none"> Mineral oil based hydraulic fluids HFB, HFC hydraulic fluids 			
Temperature range of hydraulic fluids				
Valve with FKM seals	-20 to +80 °C (-4 to 176 °F)			
Valve with NBR seals	-30 to +80 °C (-22 to 176 °F)			

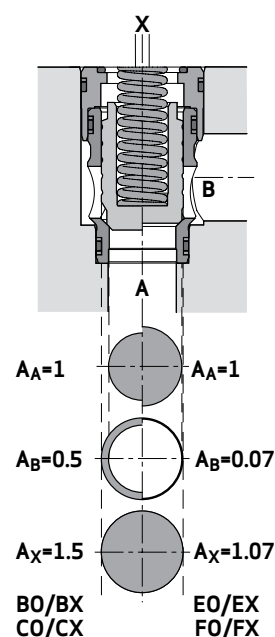

1) Please regard the maximum operating pressure of control cover and pilot valve.

Preferred Slip-in Cartridge Valve Types

With poppet type	Spring strength	Product code	Part number
BO	Spring S - 1.0 bar (15 psi)	N-CEE16K6BOS/KOB	X731-016BOS-000N00
BO	Spring T - 1.9 bar (28 psi)	N-CEE16K6BOT/KOB	X731-016BOT-000N00
BO	Spring U - 3.8 bar (55 psi)	N-CEE16K6BOU/KOB	X731-016BOU-000N00
BX	Spring U - 3.8 bar (55 psi)	N-CEE16K6BXU/KOB	X731-016BXU-000N00
CO	Spring S - 1.0 bar (15 psi)	N-CEE16K6COS/KOB	X731-016COS-000N00
CO	Spring T - 1.9 bar (28 psi)	N-CEE16K6COT/KOB	X731-016COT-000N00
CO	Spring U - 3.8 bar (55 psi)	N-CEE16K6COU/KOB	X731-016COU-000N00
CX	Spring U - 3.8 bar (55 psi)	N-CEE16K6CXU/KOB	X731-016CXU-000N00
EO	Spring S - 0.7 bar (10 psi)	N-CEE16K6EOS/KOB	X731-016EOS-000N00
EO	Spring T - 1.4 bar (20 psi)	N-CEE16K6EOT/KOB	X731-016EOT-000N00
EO	Spring U - 2.7 bar (39 psi)	N-CEE16K6EOU/KOB	X731-016EOU-000N00
EX	Spring U - 2.7 bar (39 psi)	N-CEE16K6EXU/KOB	X731-016EXU-000N00
FO	Spring S - 0.7 bar (10 psi)	N-CEE16K6FOS/KOB	X731-016FOS-000N00
FO	Spring T - 1.4 bar (20 psi)	N-CEE16K6FOT/KOB	X731-016FOT-000N00
FO	Spring U - 2.7 bar (39 psi)	N-CEE16K6FOU/KOB	X731-016FOU-000N00
FX	Spring U - 2.7 bar (39 psi)	N-CEE16K6FXU/KOB	X731-016FXU-000N00

SIZE 16 - DIRECTIONAL CONTROL

Hydraulic Symbol

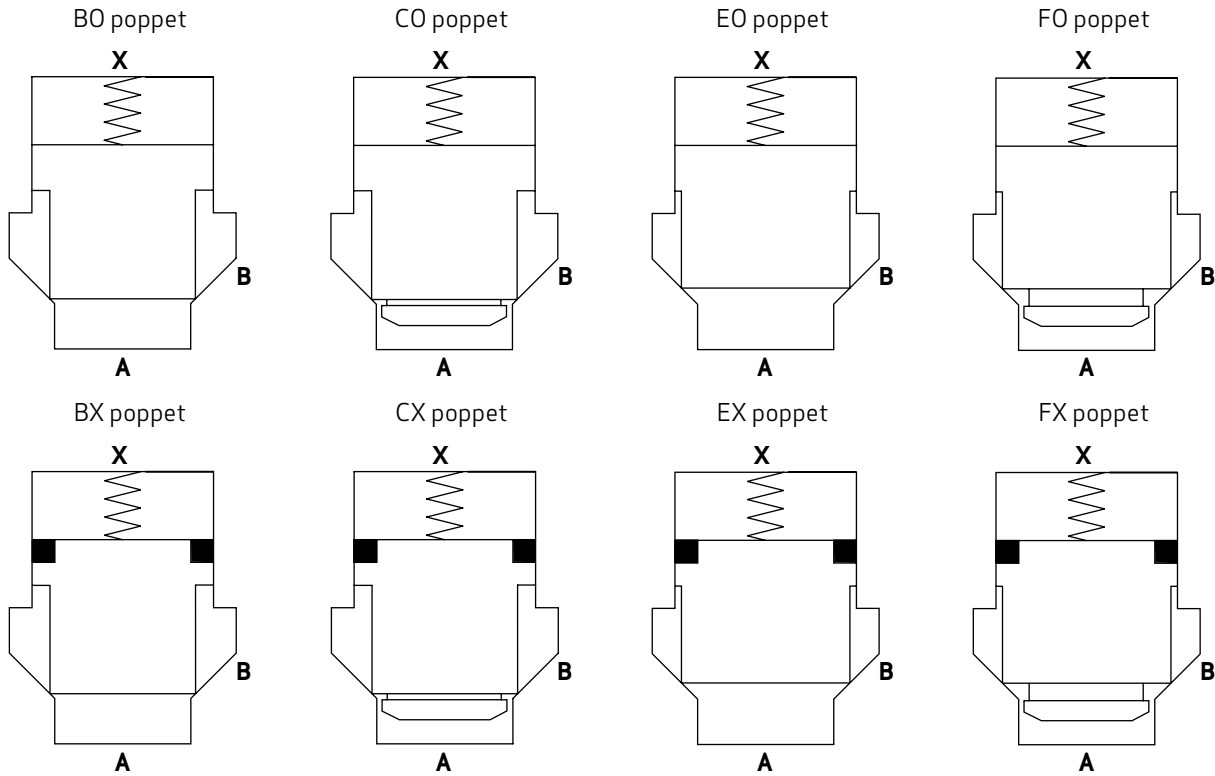

Valve Flow Diagram

Measuring conditions: Oil viscosity 32 mm²/s (cSt), oil temperature 40 °C (104 °F), port B drilled with d4_{max} as per ISO 7368, valve fully opened

BO/BX, CO/CX poppet

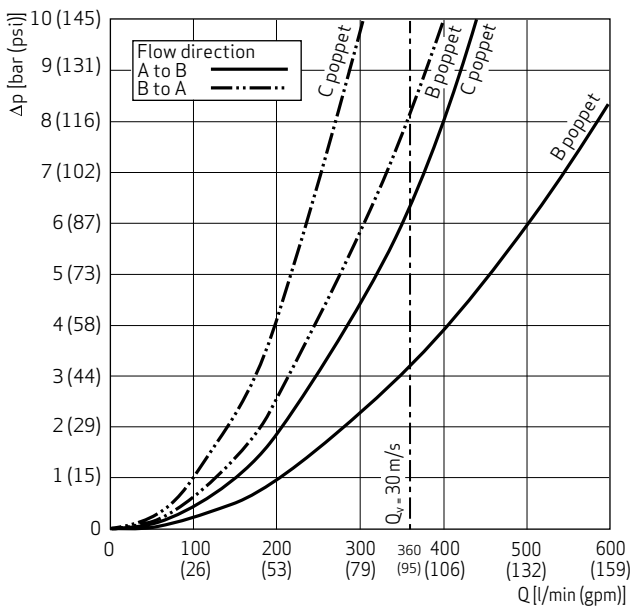

EO/EX, FO/FX poppet

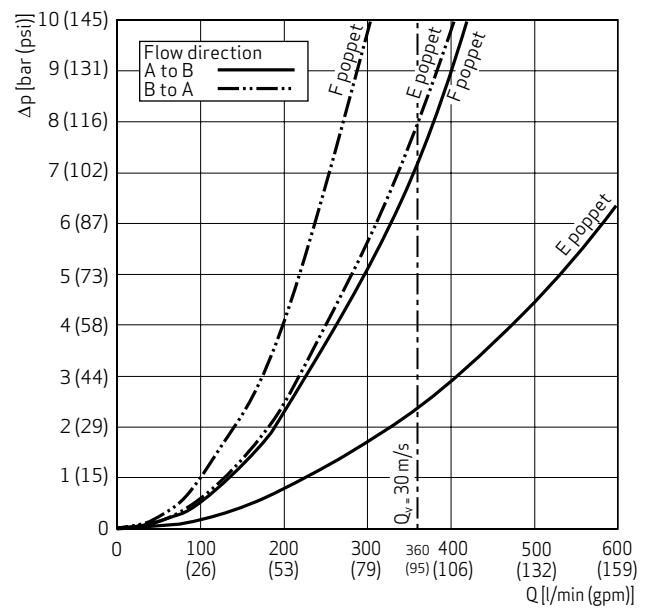

SIZE 16 - PRESSURE CONTROL

General Technical Data

Flow direction	A → B
Mounting pattern	ISO 7368-BA-06-2-A
Weight	0.17 kg (0.4 lb)
Orifice thread size (K99 poppet only)	M6

Specific Hydraulic Data

With poppet type	AO	EX
Maximum operating pressure port A, B, X¹⁾	420 bar (6,000 psi)	
Pilot volume (area A_x)	1.81 cm ³ (0.11 in ³)	2.83 cm ³ (0.17 in ³)
Control panel		
Poppet stroke	9 mm (0.35 in)	
Surface A_A	201 mm ² (0.31 in ²)	290 mm ² (0.45 in ²)
Factor A _A	1	
Factor A _B	0	0.07
Factor A _X	1	1.07
Seal material/hydraulic fluid combination		
FKM	<ul style="list-style-type: none"> Mineral oil based hydraulic fluids HFD hydraulic fluids 	
NBR	<ul style="list-style-type: none"> Mineral oil based hydraulic fluids HFB, HFC hydraulic fluids 	
Temperature range of hydraulic fluids		
Valve with FKM seals	-20 to +80 °C (-4 to 176 °F)	
Valve with NBR seals	-30 to +80 °C (-22 to 176 °F)	

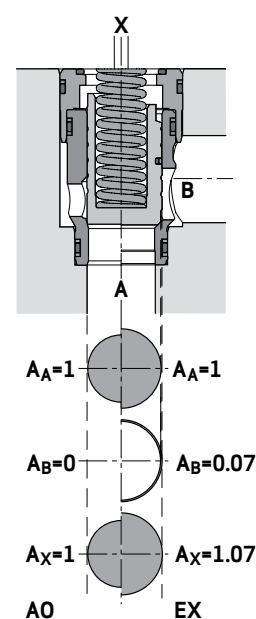

1) Please regard the maximum operating pressure of control cover and pilot valve.

Preferred Slip-in Cartridge Valve Types

With poppet type	Spring strength	Product code	Part number
AO/KOB	Spring S - 1 bar (15 psi)	N-CEE16K6AOS/KOB	X731-016AOS-000N00
AO/KOB	Spring T - 2 bar (29 psi)	N-CEE16K6AOT/KOB	X731-016AOT-000N00
AO/KOB	Spring U - 4 bar (58 psi)	N-CEE16K6AOU/KOB	X731-016AOU-000N00
AO/K99	Spring S - 1 bar (15 psi)	N-CEE16K6AOS/K99	X731-016AOS-001N00
AO/K99	Spring T - 2 bar (29 psi)	N-CEE16K6AOT/K99	X731-016AOT-001N00
AO/K99	Spring U - 4 bar (58 psi)	N-CEE16K6AOU/K99	X731-016AOU-001N00
EX/KOB	Spring U - 2.7 bar (39 psi)	N-CEE16K6EXU/KOB	X731-016EXU-000N00
EX/K99	Spring U - 2.7 bar (39 psi)	N-CEE16K6EXU/K99	X731-016EXU-001N00

SIZE 16 - PRESSURE CONTROL

Hydraulic Symbol

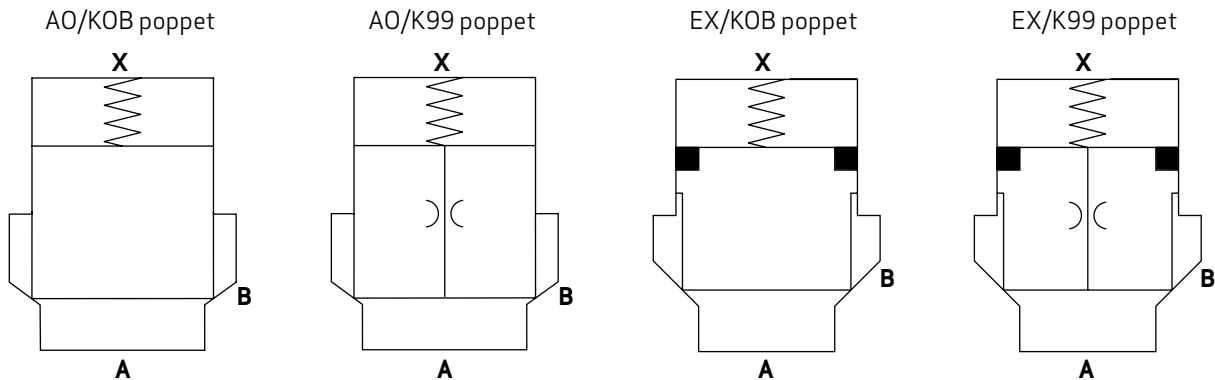

Valve Flow Diagram

Measuring conditions: Oil viscosity 32 mm²/s (cSt), oil temperature 40 °C (104 °F), flow A→B, port B drilled with d4_{max} as per ISO 7368, valve fully opened

AO poppets

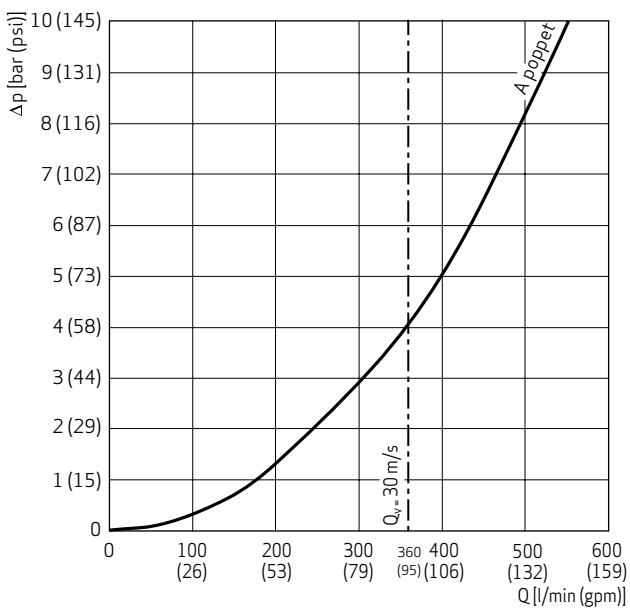

EX poppet

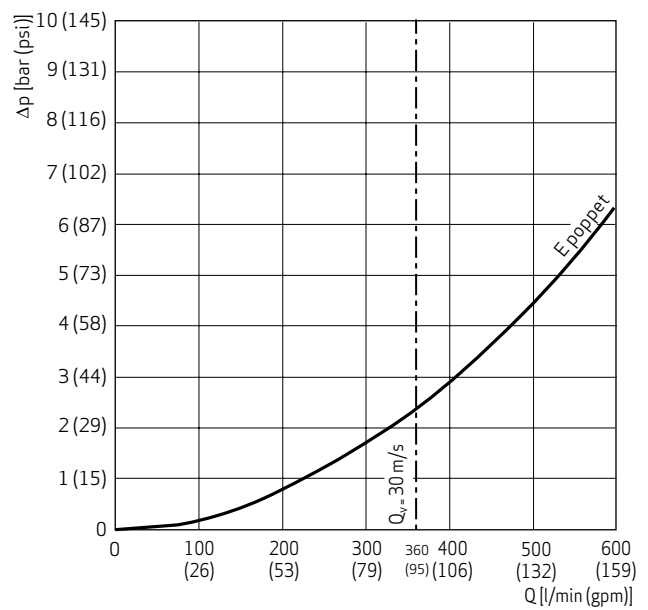

Notes

- Characteristic curves for pressure relief functions are included in the relevant catalog.
- Cartridges with AO poppets should only be used for pressure control. For a pressure relief function it is important that the pressure in port X not greatly exceeds the pressure in port A, otherwise damage to the valve seat may occur.

SIZE 25 - DIRECTIONAL CONTROL

General Technical Data

Flow direction	A ↔ B
Mounting pattern	ISO 7368-BB-08-2-A
Weight	0.4 kg (0.9 lb)

Specific Hydraulic Data

With poppet type	BO/BX	CO/CX	EO/EX	FO/FX
Maximum operating pressure port A, B, X ¹⁾	420 bar (6,000 psi)			
Pilot volume (area A_x)	9.19 cm ³ (0.56 in ³)			
Control panel				
Poppet stroke	13 mm (0.51 in)			
Surface A_A	471 mm ² (0.73 in ²)	661 mm ² (1.02 in ²)		
Factor A _A	1			
Factor A _B	0.5	0.07		
Factor A _X	1.5	1.07		
Seal material/hydraulic fluid combination				
FKM	<ul style="list-style-type: none"> Mineral oil based hydraulic fluids HFD hydraulic fluids 			
NBR	<ul style="list-style-type: none"> Mineral oil based hydraulic fluids HFB, HFC hydraulic fluids 			
Temperature range of hydraulic fluids				
Valve with FKM seals	-20 to +80 °C (-4 to 176 °F)			
Valve with NBR seals	-30 to +80 °C (-22 to 176 °F)			

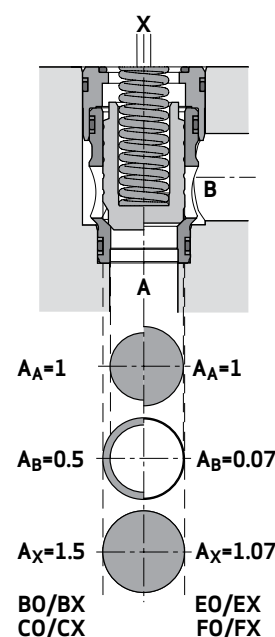

1) Please regard the maximum operating pressure of control cover and pilot valve.

Preferred Slip-in Cartridge Valve Types

With poppet type	Spring strength	Product code	Part number
BO	Spring S - 1 bar (15 psi)	N-CEE25K6BOS/KOB	X731-025BOS-000N00
BO	Spring T - 2.1 bar (30 psi)	N-CEE25K6BOT/KOB	X731-025BOT-000N00
BO	Spring U - 4.2 bar (61 psi)	N-CEE25K6BOU/KOB	X731-025BOU-000N00
BX	Spring U - 4.2 bar (61 psi)	N-CEE25K6BXU/KOB	X731-025BXU-000N00
CO	Spring S - 1 bar (15 psi)	N-CEE25K6COS/KOB	X731-025COS-000N00
CO	Spring T - 2.1 bar (30 psi)	N-CEE25K6COT/KOB	X731-025COT-000N00
CO	Spring U - 4.2 bar (61 psi)	N-CEE25K6COU/KOB	X731-025COU-000N00
CX	Spring U - 4.2 bar (61 psi)	N-CEE25K6CXU/KOB	X731-025CXU-000N00
EO	Spring S - 0.7 bar (10 psi)	N-CEE25K6EOS/KOB	X731-025EOS-000N00
EO	Spring T - 1.5 bar (22 psi)	N-CEE25K6EOT/KOB	X731-025EOT-000N00
EO	Spring U - 3.0 bar (44 psi)	N-CEE25K6EOU/KOB	X731-025EOU-000N00
EX	Spring U - 3.0 bar (44 psi)	N-CEE25K6EXU/KOB	X731-025EXU-000N00
FO	Spring S - 0.7 bar (10 psi)	N-CEE25K6FOS/KOB	X731-025FOS-000N00
FO	Spring T - 1.5 bar (22 psi)	N-CEE25K6FOT/KOB	X731-025FOT-000N00
FO	Spring U - 3.0 bar (44 psi)	N-CEE25K6FOU/KOB	X731-025FOU-000N00
FX	Spring U - 3.0 bar (44 psi)	N-CEE25K6FXU/KOB	X731-025FXU-000N00

SIZE 25 - DIRECTIONAL CONTROL

Hydraulic Symbol

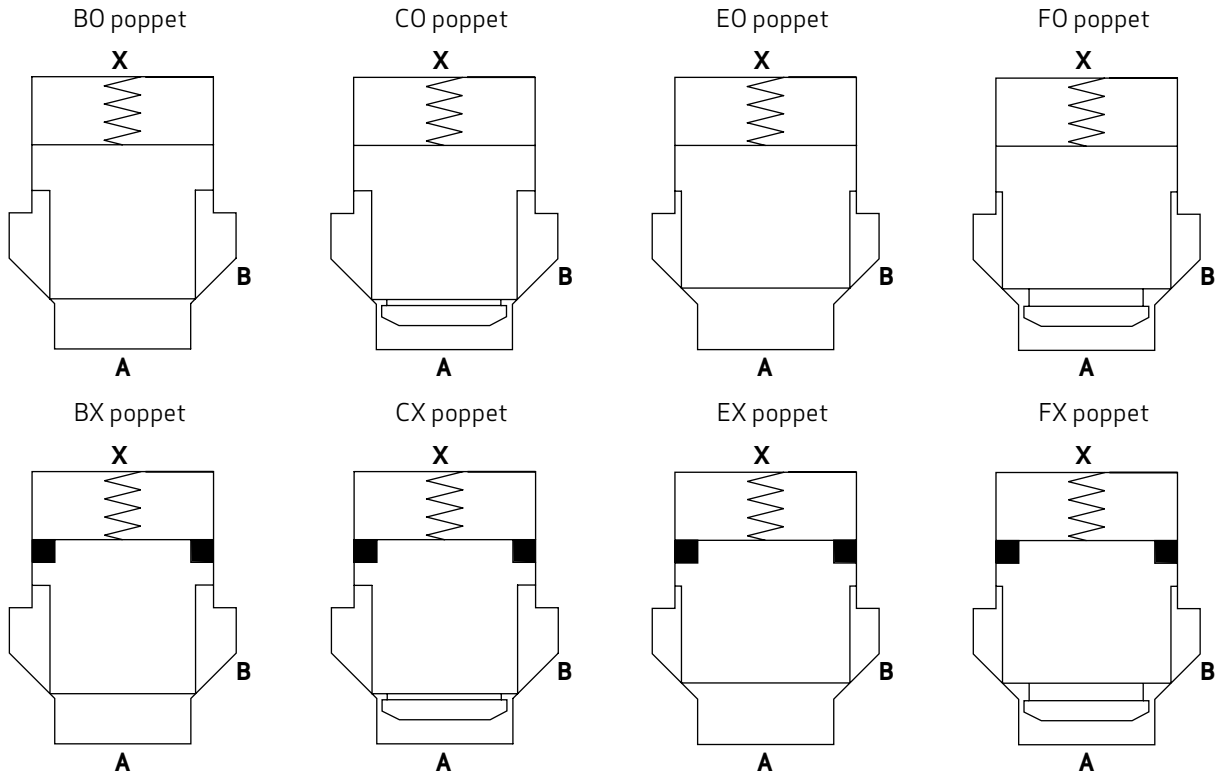

Valve Flow Diagram

Measuring conditions: Oil viscosity 32 mm²/s (cSt), oil temperature 40 °C (104 °F), port B drilled with d_{max} as per ISO 7368, valve fully opened

BO/BX, CO/CX poppet

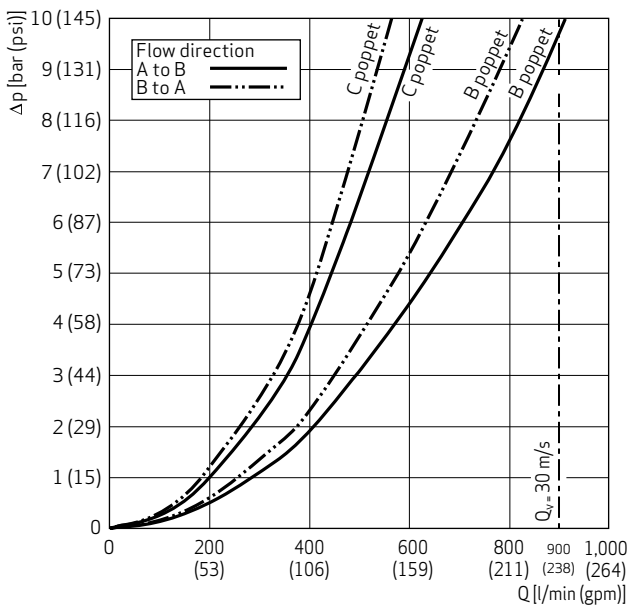

EO/EX, FO/FX poppet

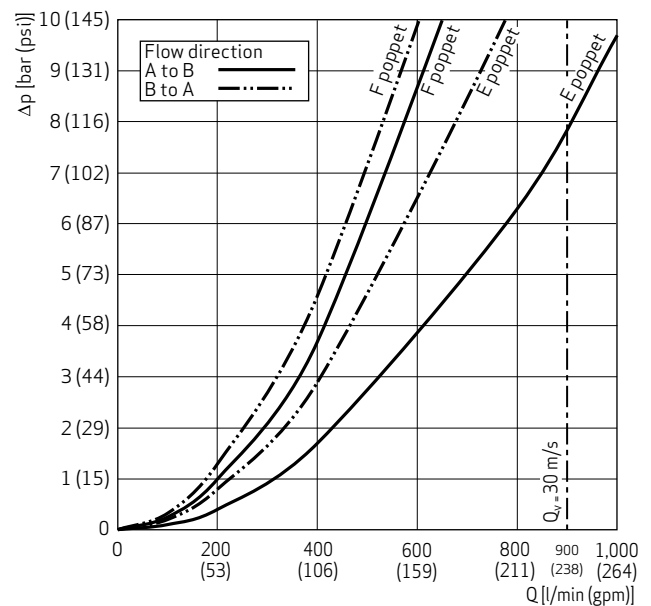

SIZE 25 - PRESSURE CONTROL

General Technical Data

Flow direction	A → B
Mounting pattern	ISO 7368-BB-08-2-A
Weight	0.4 kg (0.9 lb)
Orifice thread size (K99 poppet only)	M6

Specific Hydraulic Data

With poppet type	AO	EX
Maximum operating pressure port A, B, X¹⁾	420 bar (6,000 psi)	
Pilot volume (area A_x)	4.42 cm ³ (0.26 in ³)	9.19 cm ³ (0.56 in ³)
Control panel		
Poppet stroke	9 mm (0.35 in)	13 mm (0.51 in)
Surface A_A	491 mm ² (0.76 in ²)	661 mm ² (1.02 in ²)
Factor A _A	1	
Factor A _B	0	0.07
Factor A _X	1	1.07
Seal material/hydraulic fluid combination		
FKM	<ul style="list-style-type: none"> Mineral oil based hydraulic fluids HFD hydraulic fluids 	
NBR	<ul style="list-style-type: none"> Mineral oil based hydraulic fluids HFB, HFC hydraulic fluids 	
Temperature range of hydraulic fluids		
Valve with FKM seals	-20 to +80 °C (-4 to 176 °F)	
Valve with NBR seals	-30 to +80 °C (-22 to 176 °F)	

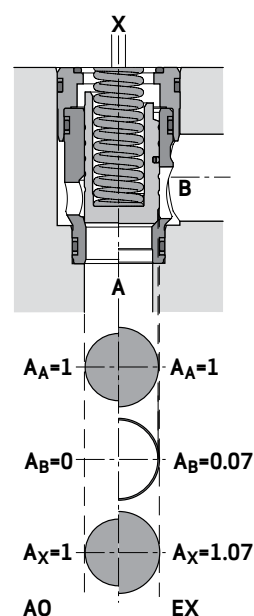

1) Please regard the maximum operating pressure of control cover and pilot valve.

Preferred Slip-in Cartridge Valve Types

With poppet type	Spring strength	Product code	Part number
AO/KOB	Spring S - 1.0 bar (15 psi)	N-CEE25K6AOS/KOB	X731-025AOS-000N00
AO/KOB	Spring T - 2.0 bar (29 psi)	N-CEE25K6AOT/KOB	X731-025AOT-000N00
AO/KOB	Spring U - 4.0 bar (58 psi)	N-CEE25K6AOU/KOB	X731-025AOU-000N00
AO/K99	Spring S - 1.0 bar (15 psi)	N-CEE25K6AOS/K99	X731-025AOS-001N00
AO/K99	Spring T - 2.0 bar (29 psi)	N-CEE25K6AOT/K99	X731-025AOT-001N00
AO/K99	Spring U - 4.0 bar (58 psi)	N-CEE25K6AOU/K99	X731-025AOU-001N00
EX/KOB	Spring U - 3.0 bar (44 psi)	N-CEE25K6EXU/KOB	X731-025EXU-000N00
EX/K99	Spring U - 3.0 bar (44 psi)	N-CEE25K6EXU/K99	X731-025EXU-001N00

SIZE 25 - PRESSURE CONTROL

Hydraulic Symbol

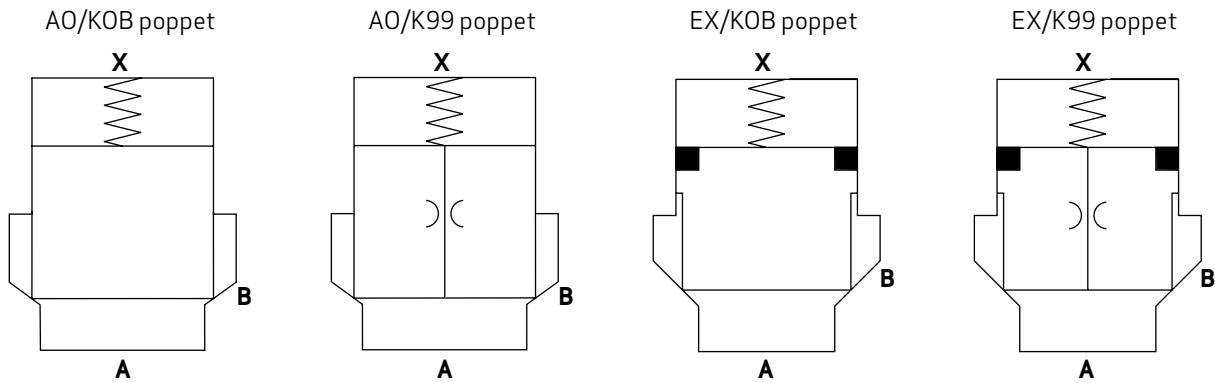

Valve Flow Diagram

Measuring conditions: Oil viscosity 32 mm²/s (cSt), oil temperature 40 °C (104 °F), flow A→B, port B drilled with d4_{max} as per ISO 7368, valve fully opened

AO poppets

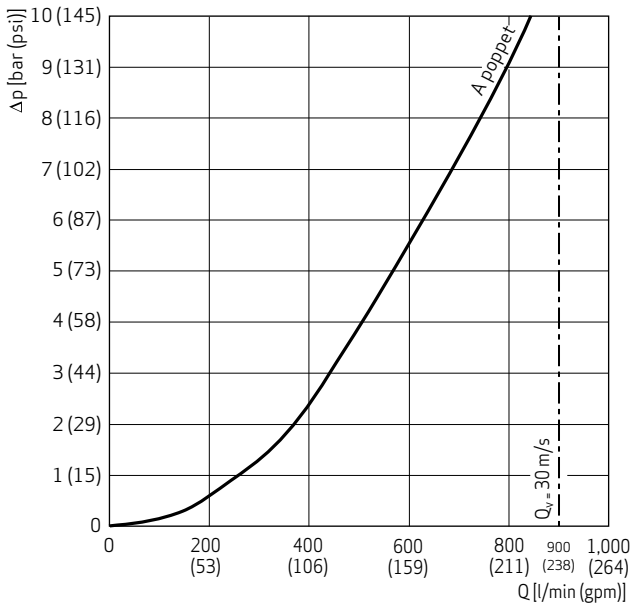

EX poppet

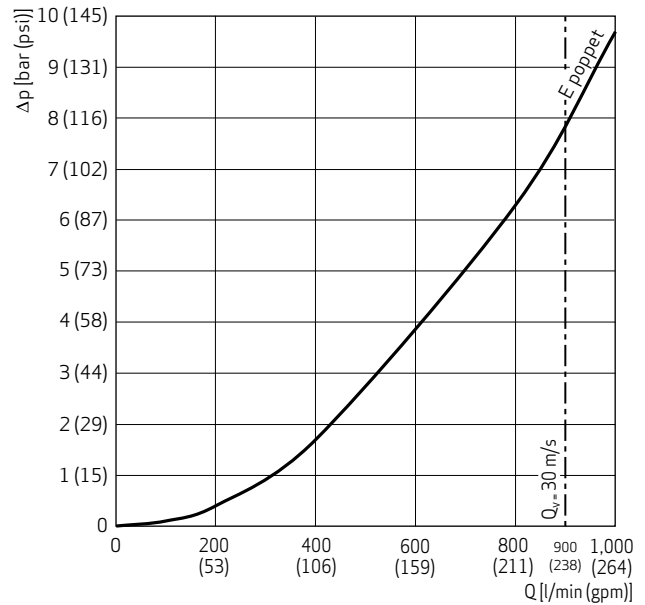

Notes

- Characteristic curves for pressure relief functions are included in the relevant catalog.
- Cartridges with AO poppets should only be used for pressure control. For a pressure relief function it is important that the pressure in port X not greatly exceeds the pressure in port A, otherwise damage to the valve seat may occur.

SIZE 32 - DIRECTIONAL CONTROL

General Technical Data

Flow direction	A ↔ B
Mounting pattern	ISO 7368-BC-09-2-A
Weight	0.9 kg (2 lb)

Specific hydraulic data

With poppet type	BO/BX	CO/CX	EO/EX	FO/FX
Maximum operating pressure port A, B, X¹⁾	420 bar (6,000 psi)			
Pilot volume (area A_X)	17.92 cm ³ (1.09 in ³)			
Control panel				
Poppet stroke	15 mm (0.59 in)			
Surface A_A	794 mm ² (1.23 in ²)	1,116 mm ² (1.73 in ²)		
Factor A _A	1			
Factor A _B	0.5	0.07		
Factor A _X	1.5	1.07		
Seal material/hydraulic fluid combination				
FKM	<ul style="list-style-type: none"> Mineral oil based hydraulic fluids HFD hydraulic fluids 			
NBR	<ul style="list-style-type: none"> Mineral oil based hydraulic fluids HFB, HFC hydraulic fluids 			
Temperature range of hydraulic fluids				
Valve with FKM seals	-20 to +80 °C (-4 to 176 °F)			
Valve with NBR seals	-30 to +80 °C (-22 to 176 °F)			

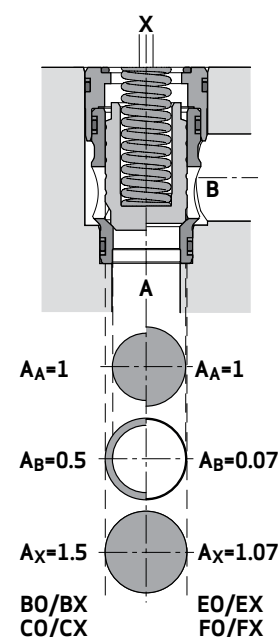

1) Please regard the maximum operating pressure of control cover and pilot valve.

Preferred Slip-in Cartridge Valve Types

With poppet type	Spring strength	Product code	Part number
BO	Spring S - 1.0 bar (15 psi)	N-CEE32K6BOS/KOB	X731-032BOS-000N00
BO	Spring T - 2.0 bar (29 psi)	N-CEE32K6BOT/KOB	X731-032BOT-000N00
BO	Spring U - 4.0 bar (58 psi)	N-CEE32K6BOU/KOB	X731-032BOU-000N00
BX	Spring U - 4.0 bar (58 psi)	N-CEE32K6BXU/KOB	X731-032BXU-000N00
CO	Spring S - 1.0 bar (15 psi)	N-CEE32K6COS/KOB	X731-032COS-000N00
CO	Spring T - 2.0 bar (29 psi)	N-CEE32K6COT/KOB	X731-032COT-000N00
CO	Spring U - 4.0 bar (58 psi)	N-CEE32K6COU/KOB	X731-032COU-000N00
CX	Spring U - 4.0 bar (58 psi)	N-CEE32K6CXU/KOB	X731-032CXU-000N00
EO	Spring S - 0.7 bar (10 psi)	N-CEE32K6EOS/KOB	X731-032EOS-000N00
EO	Spring T - 1.4 bar (20 psi)	N-CEE32K6EOT/KOB	X731-032EOT-000N00
EO	Spring U - 2.8 bar (41 psi)	N-CEE32K6EOU/KOB	X731-032EOU-000N00
EX	Spring U - 2.8 bar (41 psi)	N-CEE32K6EXU/KOB	X731-032EXU-000N00
FO	Spring S - 0.7 bar (10 psi)	N-CEE32K6FOS/KOB	X731-032FOS-000N00
FO	Spring T - 1.4 bar (20 psi)	N-CEE32K6FOT/KOB	X731-032EOT-000N00
FO	Spring U - 2.8 bar (41 psi)	N-CEE32K6FOU/KOB	X731-032FOU-000N00
FX	Spring U - 2.8 bar (41 psi)	N-CEE32K6FXU/KOB	X731-032FXU-000N00

SIZE 32 - DIRECTIONAL CONTROL

Hydraulic Symbol

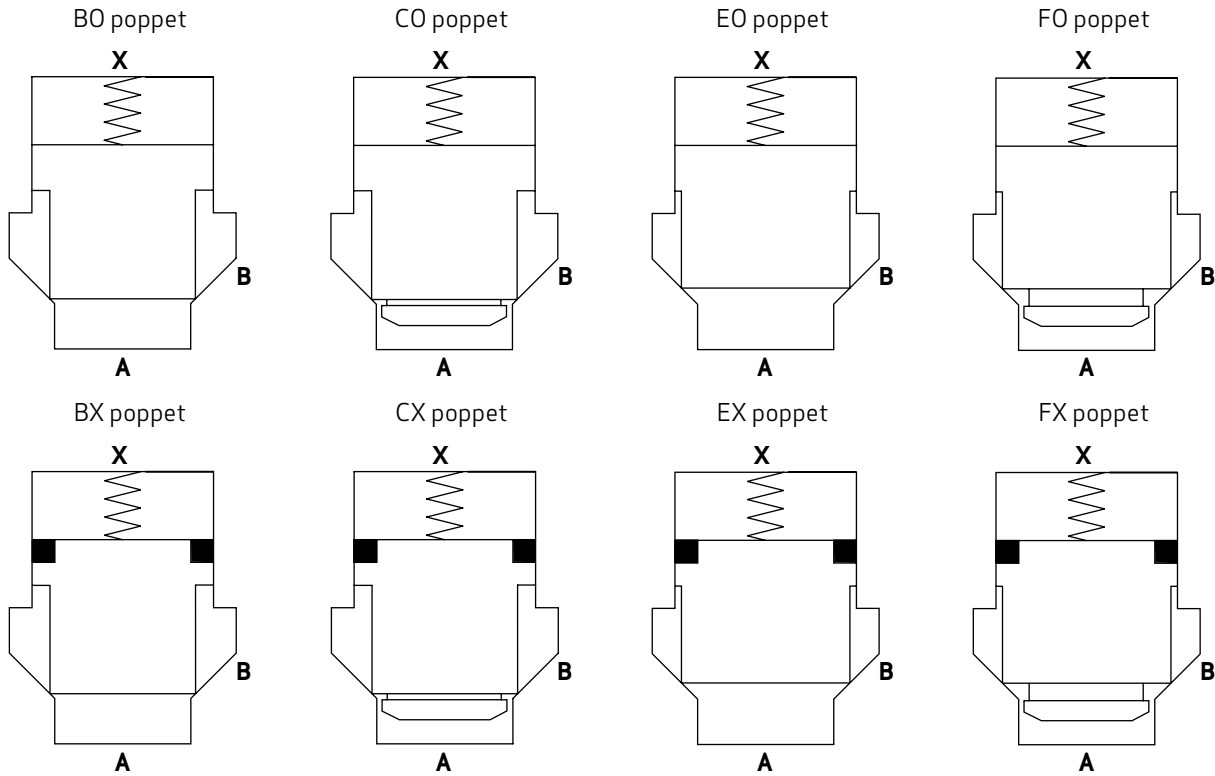

Valve Flow Diagram

Measuring conditions: Oil viscosity 32 mm²/s (cSt), oil temperature 40 °C (104 °F), port B drilled with d_{max} as per ISO 7368, valve fully opened

BO/BX, CO/CX poppet

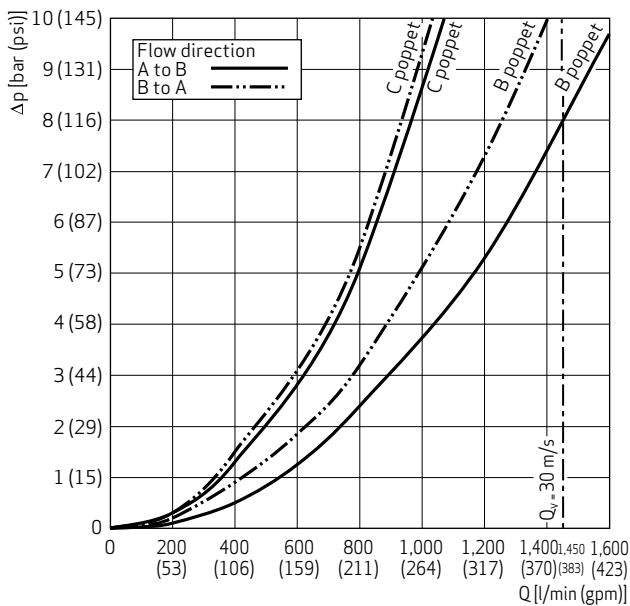

EO/EX, FO/FX poppet

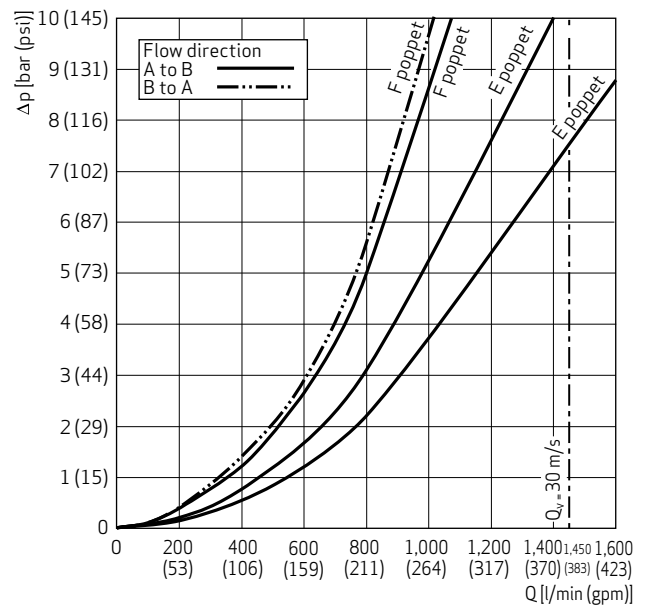

SIZE 32 - PRESSURE CONTROL

General Technical Data

Flow direction	A → B
Mounting pattern	ISO 7368-BC-09-2-A
Weight	0.9 kg (2 lb)
Orifice thread size (K99 poppet only)	M6

Specific hydraulic data

With poppet type	AO	EX
Maximum operating pressure port A, B, X ¹⁾	420 bar (6,000 psi)	
Pilot volume (area A _x)	12.06 cm ³ (0.73 in ³)	17.92 cm ³ (1.09 in ³)
Control panel		
Poppet stroke	15 mm (0.59 in)	
Surface A _A	804 mm ² (1.25 in ²)	1,116 mm ² (1.73 in ²)
Factor A _A	1	
Factor A _B	0	0.07
Factor A _x	1	1.07
Seal material/hydraulic fluid combination		
FKM	<ul style="list-style-type: none"> Mineral oil based hydraulic fluids HFD hydraulic fluids 	
NBR	<ul style="list-style-type: none"> Mineral oil based hydraulic fluids HFB, HFC hydraulic fluids 	
Temperature range of hydraulic fluids		
Valve with FKM seals	-20 to +80 °C (-4 to 176 °F)	
Valve with NBR seals	-30 to +80 °C (-22 to 176 °F)	

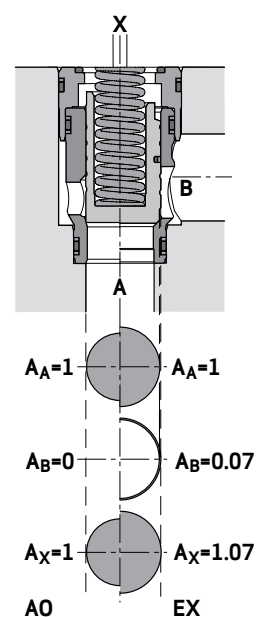

1) Please regard the maximum operating pressure of control cover and pilot valve.

Preferred Slip-in Cartridge Valve Types

With poppet type	Spring strength	Product code	Part number
AO/KOB	Spring S - 1.0 bar (15 psi)	N-CEE32K6AOS/KOB	X731-032AOS-000N00
AO/KOB	Spring T - 2.0 bar (29 psi)	N-CEE32K6AOT/KOB	X731-032AOT-000N00
AO/KOB	Spring U - 4.0 bar (58 psi)	N-CEE32K6AOU/KOB	X731-032AOU-000N00
AO/K99	Spring S - 1.0 bar (15 psi)	N-CEE32K6AOS/K99	X731-032AOS-001N00
AO/K99	Spring T - 2.0 bar (29 psi)	N-CEE32K6AOT/K99	X731-032AOT-001N00
AO/K99	Spring U - 4.0 bar (58 psi)	N-CEE32K6AOU/K99	X731-032AOU-001N00
EX/KOB	Spring U - 2.8 bar (41 psi)	N-CEE32K6EXU/KOB	X731-032EXU-000N00
EX/K99	Spring U - 2.8 bar (41 psi)	N-CEE32K6EXU/K99	X731-032EXU-001N00

SIZE 32 - PRESSURE CONTROL

Hydraulic Symbol

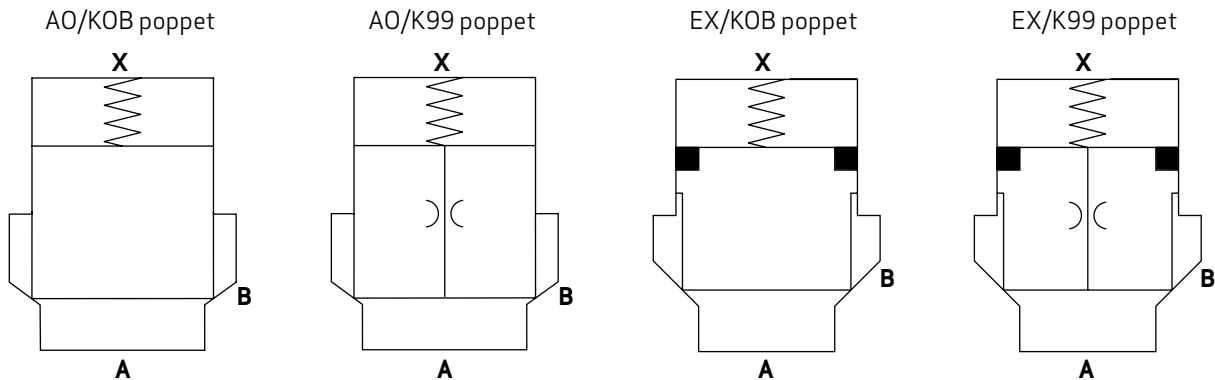

Valve Flow Diagram

Measuring conditions: Oil viscosity 32 mm²/s (cSt), oil temperature 40 °C (104 °F), flow A→B, port B drilled with d4_{max} as per ISO 7368, valve fully opened

AO poppets

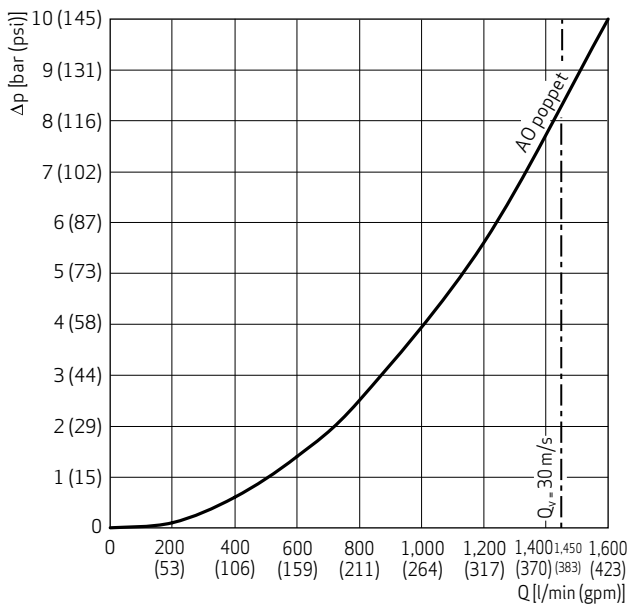

EX poppet

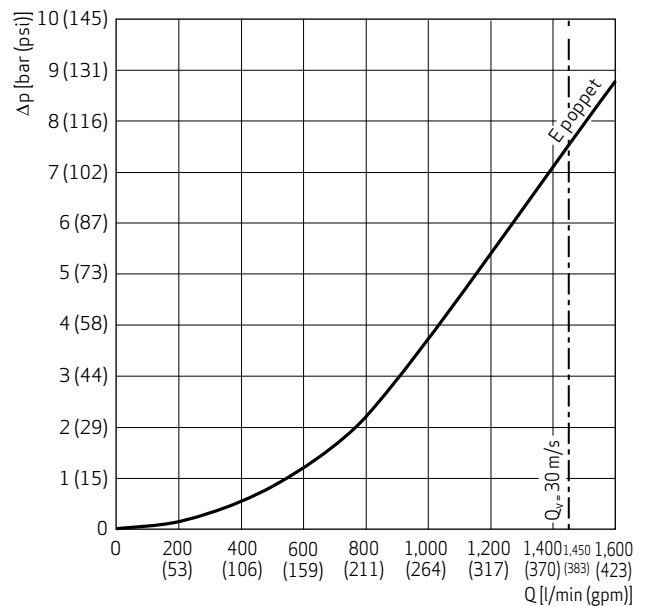

Notes

- Characteristic curves for pressure relief functions are included in the relevant catalog.
- Cartridges with AO poppets should only be used for pressure control. For a pressure relief function it is important that the pressure in port X not greatly exceeds the pressure in port A, otherwise damage to the valve seat may occur.

SIZE 40 - DIRECTIONAL CONTROL

General Technical Data

Flow direction	A ↔ B
Mounting pattern	ISO 7368-BD-10-2-A
Weight	1.8 kg (4 lb)

Specific Hydraulic Data

With poppet type	BO/BX	CO/CX	EO/EX	FO/FX
Maximum operating pressure port A, B, X¹⁾	420 bar (6,000 psi)			
Pilot volume (area A_x)	33.24 cm ³ (2.02 in ³)			
Control panel				
Poppet stroke	20 mm (0.79 in)			
Surface A_A	1,110 mm ² (1.72 in ²)	1,555 mm ² (2.41 in ²)		
Factor A _A	1			
Factor A _B	0.5	0.07		
Factor A _X	1.5	1.07		
Seal material/hydraulic fluid combination				
FKM	<ul style="list-style-type: none"> Mineral oil based hydraulic fluids HFD hydraulic fluids 			
NBR	<ul style="list-style-type: none"> Mineral oil based hydraulic fluids HFB, HFC hydraulic fluids 			
Temperature range of hydraulic fluids				
Valve with FKM seals	-20 to +80 °C (-4 to 176 °F)			
Valve with NBR seals	-30 to +80 °C (-22 to 176 °F)			

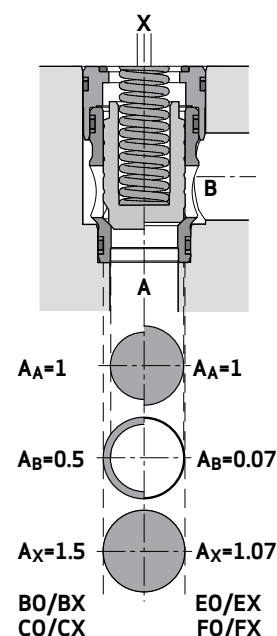

1) Please regard the maximum operating pressure of control cover and pilot valve.

Preferred Slip-in Cartridge Valve Types

With poppet type	Spring strength	Product code	Part number
BO	Spring S - 1.0 bar (15 psi)	N-CEE40K6BOS/KOB	X731-040BOS-000N00
BO	Spring T - 2.0 bar (29 psi)	N-CEE40K6BOT/KOB	X731-040BOT-000N00
BO	Spring U - 4.0 bar (58 psi)	N-CEE40K6BOU/KOB	X731-040BOU-000N00
BX	Spring U - 4.0 bar (58 psi)	N-CEE40K6BXU/KOB	X731-040BXU-000N00
CO	Spring S - 1.0 bar (15 psi)	N-CEE40K6COS/KOB	X731-040COS-000N00
CO	Spring T - 2.0 bar (29 psi)	N-CEE40K6COT/KOB	X731-040COT-000N00
CO	Spring U - 4.0 bar (58 psi)	N-CEE40K6COU/KOB	X731-040COU-000N00
CX	Spring U - 4.0 bar (58 psi)	N-CEE40K6CXU/KOB	X731-040CXU-000N00
EO	Spring S - 0.7 bar (10 psi)	N-CEE40K6EOS/KOB	X731-040EOS-000N00
EO	Spring T - 1.4 bar (20 psi)	N-CEE40K6EOT/KOB	X731-040EOT-000N00
EO	Spring U - 2.9 bar (42 psi)	N-CEE40K6EOU/KOB	X731-040EOU-000N00
EX	Spring U - 2.9 bar (42 psi)	N-CEE40K6EXU/KOB	X731-040EXU-000N00
FO	Spring S - 0.7 bar (10 psi)	N-CEE40K6FOS/KOB	X731-040FOS-000N00
FO	Spring T - 1.4 bar (20 psi)	N-CEE40K6FOT/KOB	X731-040EOT-000N00
FO	Spring U - 2.9 bar (42 psi)	N-CEE40K6FOU/KOB	X731-040FOU-000N00
FX	Spring U - 2.9 bar (42 psi)	N-CEE40K6FXU/KOB	X731-040FXU-000N00

SIZE 40 - DIRECTIONAL CONTROL

Hydraulic Symbol

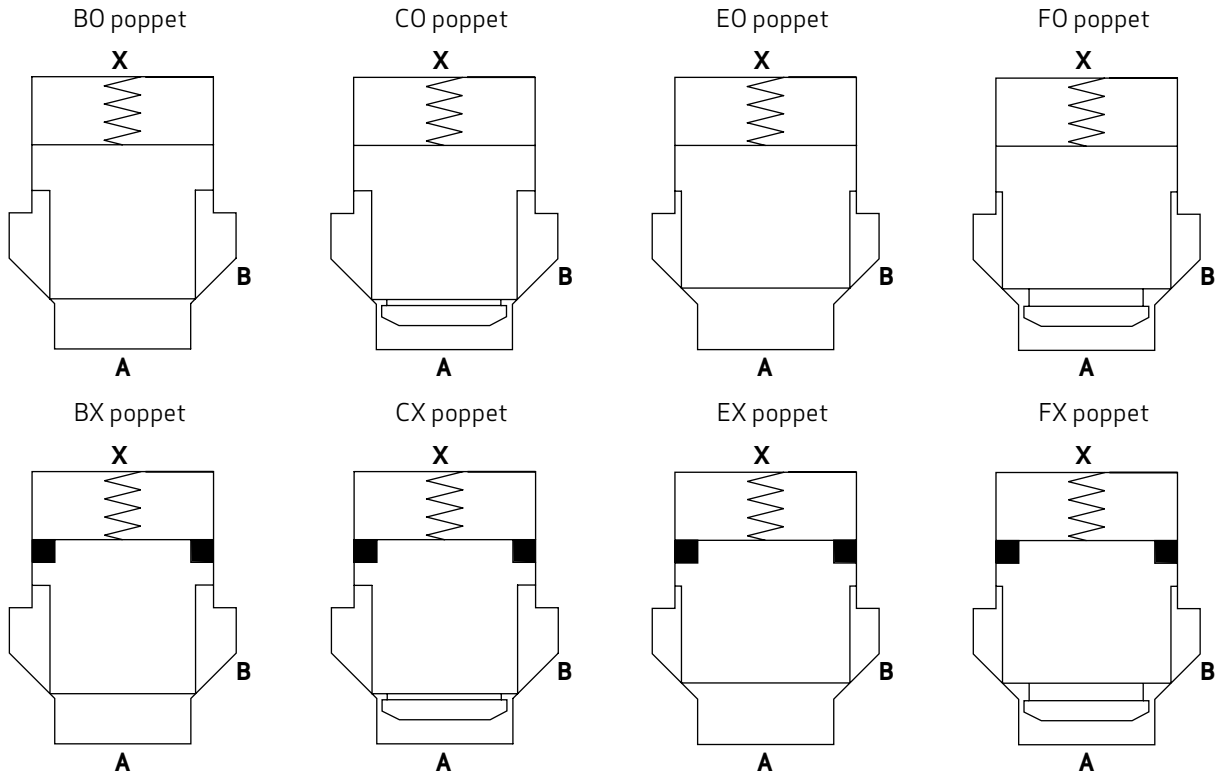

Valve Flow Diagram

Measuring conditions: Oil viscosity 32 mm²/s (cSt), oil temperature 40 °C (104 °F), port B drilled with d_{max} as per ISO 7368, valve fully opened

BO/BX, CO/CX poppet

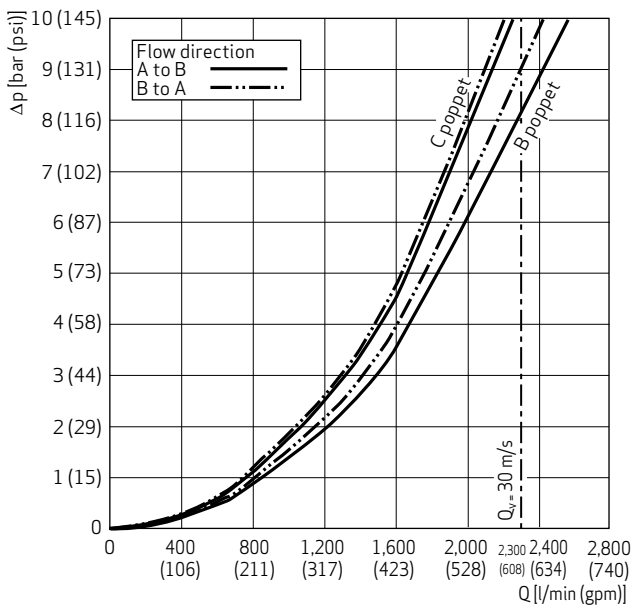

EO/EX, FO/FX poppet

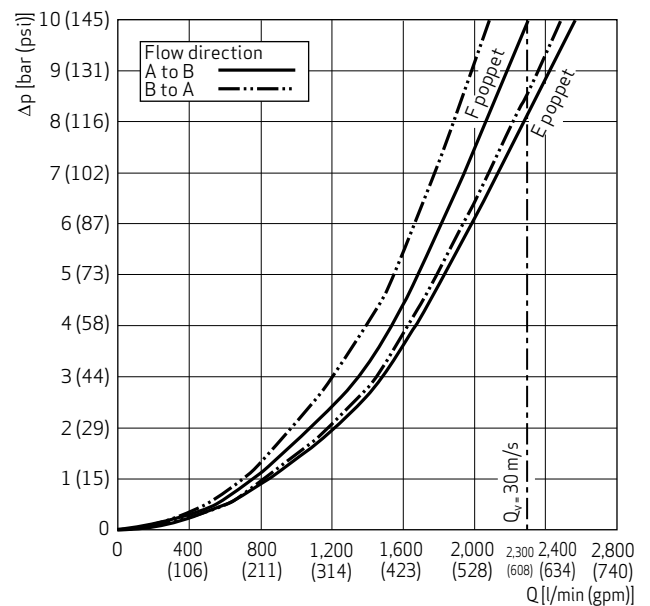

SIZE 40 - PRESSURE CONTROL

General Technical Data

Flow direction	A → B
Mounting pattern	ISO 7368-BD-10-2-A
Weight	1.8 kg (4 lb)
Orifice thread size (K99 poppet only)	M6

Specific Hydraulic Data

With poppet type	A0	EX
Maximum operating pressure port A, B, X¹⁾	420 bar (6,000 psi)	
Pilot volume (area A_x)	31.11 cm ³ (1.89 in ³)	33.24 cm ³ (2.02 in ³)
Control panel		
Poppet stroke	20 mm (0.79 in)	
Surface A_A	1,555 mm ² (2.41 in ²)	
Factor A _A	1	
Factor A _B	0	0.07
Factor A _x	1	1.07
Seal material/hydraulic fluid combination		
FKM	<ul style="list-style-type: none"> Mineral oil based hydraulic fluids HFD hydraulic fluids 	
NBR	<ul style="list-style-type: none"> Mineral oil based hydraulic fluids HFB, HFC hydraulic fluids 	
Temperature range of hydraulic fluids		
Valve with FKM seals	-20 to +80 °C (-4 to 176 °F)	
Valve with NBR seals	-30 to +80 °C (-22 to 176 °F)	

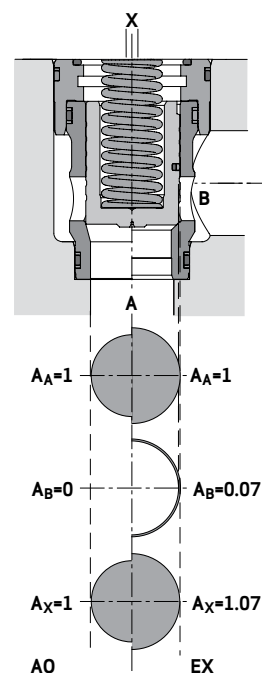

1) Please regard the maximum operating pressure of control cover and pilot valve.

Preferred Slip-in Cartridge Valve Types

With poppet type	Spring strength	Product code	Part number
A0/KOB	Spring S - 0.7 bar (10 psi)	N-CEE40K6AOS/KOB	X731-040AOS-000N00
A0/KOB	Spring T - 1.4 bar (20 psi)	N-CEE40K6AOT/KOB	X731-040AOT-000N00
A0/KOB	Spring U - 2.9 bar (42 psi)	N-CEE40K6AOU/KOB	X731-040AOU-000N00
A0/K99	Spring S - 0.7 bar (10 psi)	N-CEE40K6AOS/K99	X731-040AOS-001N00
A0/K99	Spring T - 1.4 bar (20 psi)	N-CEE40K6AOT/K99	X731-040AOT-001N00
A0/K99	Spring U - 2.9 bar (42 psi)	N-CEE40K6AOU/K99	X731-040AOU-001N00
EX/KOB	Spring U - 2.9 bar (42 psi)	N-CEE40K6EXU/KOB	X731-040EXU-000N00
EX/K99	Spring U - 2.9 bar (42 psi)	N-CEE40K6EXU/K99	X731-040EXU-001N00

SIZE 40 - PRESSURE CONTROL

Hydraulic Symbol

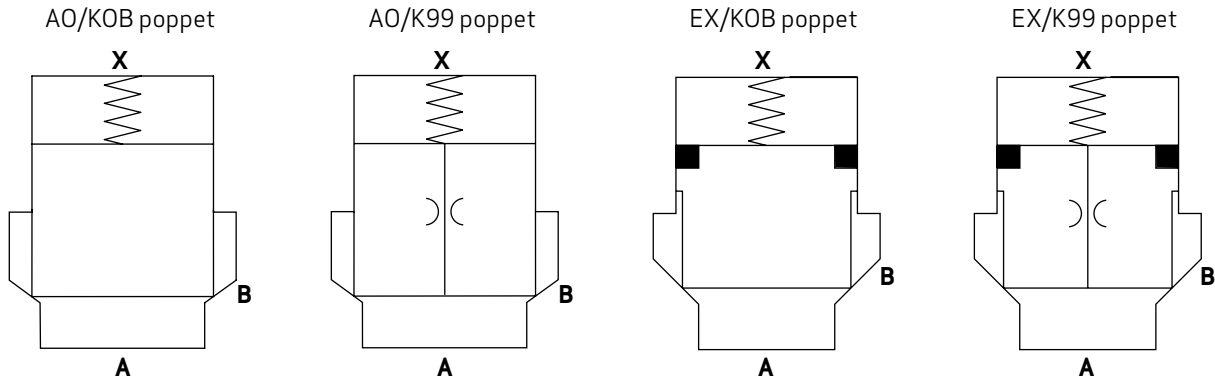

Valve Flow Diagram

Measuring conditions: Oil viscosity 32 mm²/s (cSt), oil temperature 40 °C (104 °F), flow A→B, port B drilled with d4_{max} as per ISO 7368, valve fully opened

AO poppets

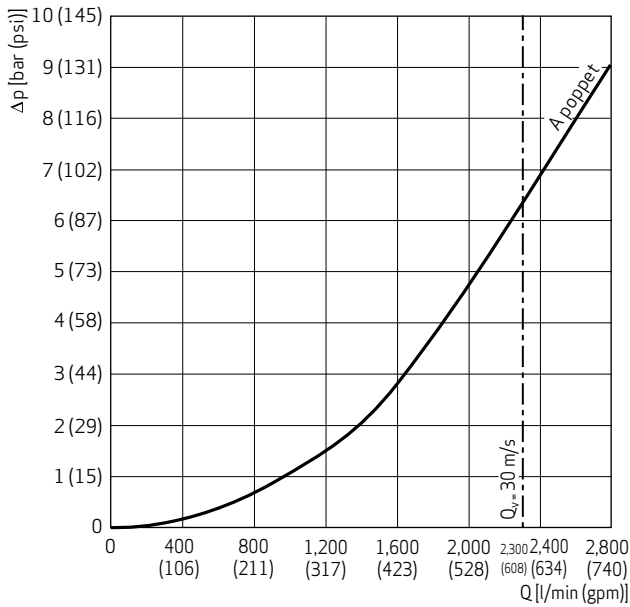

EX poppet

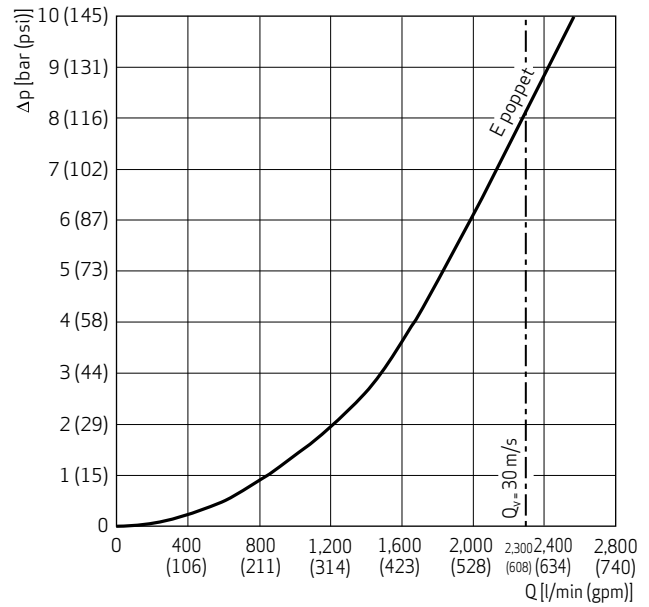

Notes

- Characteristic curves for pressure relief functions are included in the relevant catalog.
- Cartridges with AO poppets should only be used for pressure control. For a pressure relief function it is important that the pressure in port X not greatly exceeds the pressure in port A, otherwise damage to the valve seat may occur.

SIZE 50 - DIRECTIONAL CONTROL

General Technical Data

Flow direction	A ↔ B
Mounting pattern	ISO 7368-BE-11-2-A
Weight	3.2 kg (7.1 lb)

Specific Hydraulic Data

With poppet type	BO/BX	CO/CX	EO/EX	FO/FX
Maximum operating pressure port A, B, X¹⁾	420 bar (6,000 psi)			
Pilot volume (area A_x)	67.86 cm ³ (4.14 in ³)			
Control panel				
Poppet stroke	24 mm (0.95 in)			
Surface A_A	1,886 mm ² (2.92 in ²)	2,642 mm ² (4.1 in ²)		
Factor A _A	1			
Factor A _B	0.5	0.07		
Factor A _X	1.5	1.07		
Seal material/hydraulic fluid combination				
FKM	<ul style="list-style-type: none"> Mineral oil based hydraulic fluids HFD hydraulic fluids 			
NBR	<ul style="list-style-type: none"> Mineral oil based hydraulic fluids HFB, HFC hydraulic fluids 			
Temperature range of hydraulic fluids				
Valve with FKM seals	-20 to +80 °C (-4 to 176 °F)			
Valve with NBR seals	-30 to +80 °C (-22 to 176 °F)			

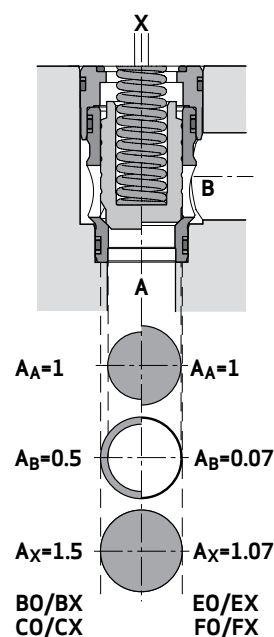

1) Please regard the maximum operating pressure of control cover and pilot valve.

Preferred Slip-in Cartridge Valve Types

With poppet type	Spring strength	Product code	Part number
BO	Spring S - 1.0 bar (15 psi)	N-CEE50K6BOS/KOB	X731-050BOS-000N00
BO	Spring T - 2.0 bar (29 psi)	N-CEE50K6BOT/KOB	X731-050BOT-000N00
BO	Spring U - 4.0 bar (58 psi)	N-CEE50K6BOU/KOB	X731-050BOU-000N00
BX	Spring U - 4.0 bar (58 psi)	N-CEE50K6BXU/KOB	X731-050BXU-000N00
CO	Spring S - 1.0 bar (15 psi)	N-CEE50K6COS/KOB	X731-050COS-000N00
CO	Spring T - 2.0 bar (29 psi)	N-CEE50K6COT/KOB	X731-050COT-000N00
CO	Spring U - 4.0 bar (58 psi)	N-CEE50K6COU/KOB	X731-050COU-000N00
CX	Spring U - 4.0 bar (58 psi)	N-CEE50K6CXU/KOB	X731-050CXU-000N00
EO	Spring S - 0.7 bar (10 psi)	N-CEE50K6EOS/KOB	X731-050EOS-000N00
EO	Spring T - 1.4 bar (20 psi)	N-CEE50K6EOT/KOB	X731-050EOT-000N00
EO	Spring U - 2.9 bar (42 psi)	N-CEE50K6EOU/KOB	X731-050EOU-000N00
EX	Spring U - 2.9 bar (42 psi)	N-CEE50K6EXU/KOB	X731-050EXU-000N00
FO	Spring S - 0.7 bar (10 psi)	N-CEE50K6FOS/KOB	X731-050FOS-000N00
FO	Spring T - 1.4 bar (20 psi)	N-CEE50K6FOT/KOB	X731-050EOT-000N00
FO	Spring U - 2.9 bar (42 psi)	N-CEE50K6FOU/KOB	X731-050FOU-000N00
FX	Spring U - 2.9 bar (42 psi)	N-CEE50K6FXU/KOB	X731-050FXU-000N00

SIZE 50 - DIRECTIONAL CONTROL

Hydraulic Symbol

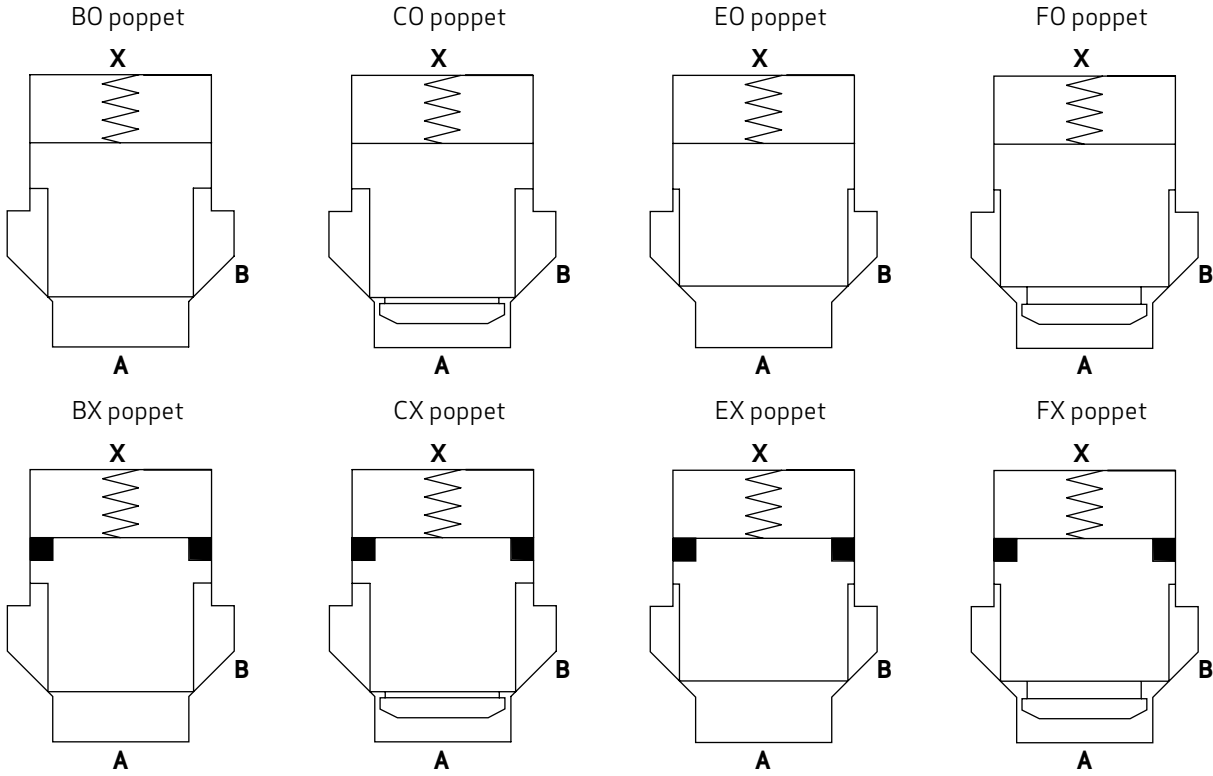

Valve Flow Diagram

Simulation conditions: Oil viscosity 32 mm²/s (cSt), oil temperature 40 °C (104 °F), port B drilled with d_{max} as per ISO 7368, valve fully opened

BO/BX, CO/CX poppet

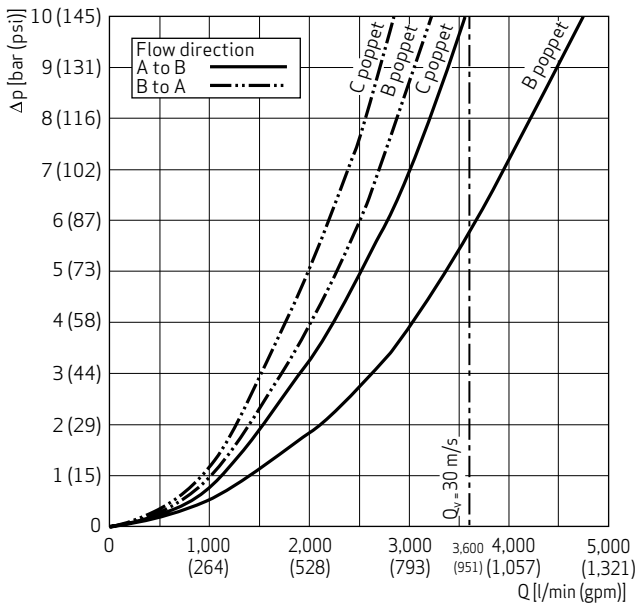

EO/EX, FO/FX poppet

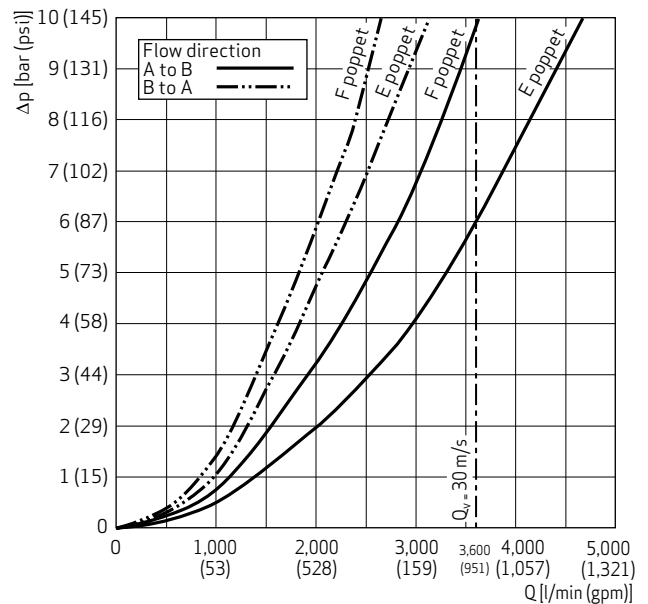

SIZE 50 - PRESSURE CONTROL

General Technical Data

Flow direction	A → B
Mounting pattern	ISO 7368-BE-11-2-A
Weight	3.2 kg (7.1 lb)
Orifice thread size (K99 poppet only)	M8

Specific Hydraulic Data

With poppet type	AO	EX
Maximum operating pressure port A, B, X¹⁾	420 bar (6,000 psi)	
Pilot volume (area A_x)	63.41 cm ³ (3.86 in ³)	67.86 cm ³ (4.14 in ³)
Control panel		
Poppet stroke	24 mm (0.95 in)	
Surface A_A	2,642 mm ² (4.1 in ²)	
Factor A _A	1	
Factor A _B	0	0.07
Factor A _X	1	1.07
Seal material/hydraulic fluid combination		
FKM	<ul style="list-style-type: none"> Mineral oil based hydraulic fluids HFD hydraulic fluids 	
NBR	<ul style="list-style-type: none"> Mineral oil based hydraulic fluids HFB, HFC hydraulic fluids 	
Temperature range of hydraulic fluids		
Valve with FKM seals	-20 to +80 °C (-4 to 176 °F)	
Valve with NBR seals	-30 to +80 °C (-22 to 176 °F)	

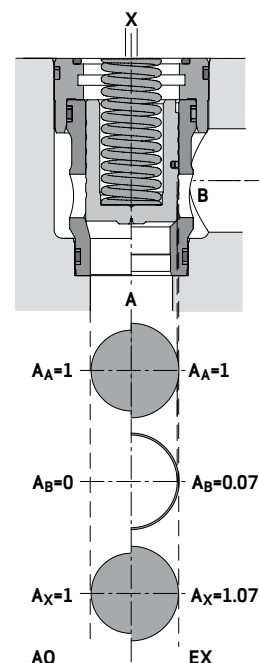

1) Please regard the maximum operating pressure of control cover and pilot valve.

Preferred Slip-in Cartridge Valve Types

With poppet type	Spring strength	Product code	Part number
AO/KOB	Spring S - 0.7 bar (10 psi)	N-CEE50K6AOS/KOB	X731-050AOS-000N00
AO/KOB	Spring T - 1.4 bar (20 psi)	N-CEE50K6AOT/KOB	X731-050AOT-000N00
AO/KOB	Spring U - 2.9 bar (42 psi)	N-CEE50K6AOU/KOB	X731-050AOU-000N00
AO/K99	Spring S - 0.7 bar (10 psi)	N-CEE50K6AOS/K99	X731-050AOS-001N00
AO/K99	Spring T - 1.4 bar (20 psi)	N-CEE50K6AOT/K99	X731-050AOT-001N00
AO/K99	Spring U - 2.9 bar (42 psi)	N-CEE50K6AOU/K99	X731-050AOU-001N00
EX/KOB	Spring U - 2.9 bar (42 psi)	N-CEE50K6EXU/KOB	X731-050EXU-000N00
EX/K99	Spring U - 2.9 bar (42 psi)	N-CEE50K6EXU/K99	X731-050EXU-001N00

SIZE 50 - PRESSURE CONTROL

Hydraulic Symbol

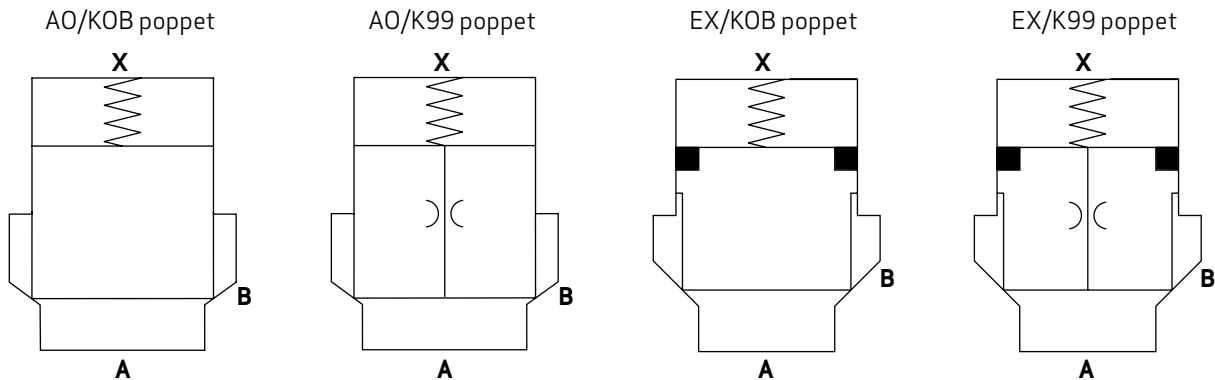

Valve Flow Diagram

Simulation conditions: Oil viscosity 32 mm²/s (cSt), oil temperature 40 °C (104 °F), flow A→B, port B drilled with d4_{max} as per ISO 7368, valve fully opened

AO poppets

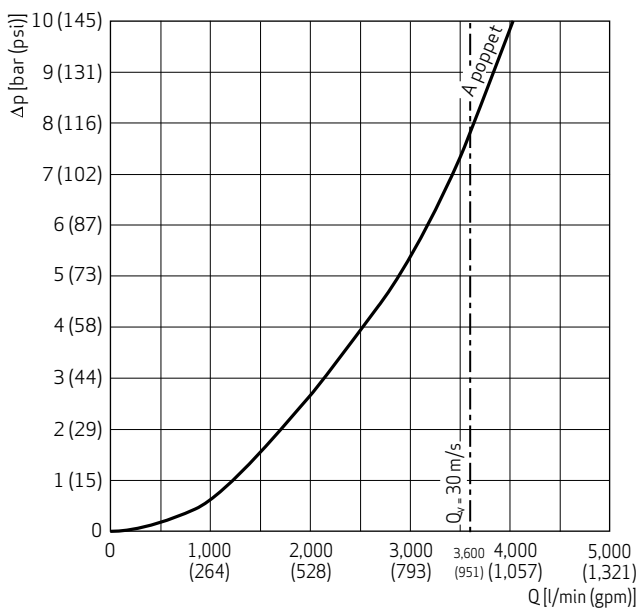

EX poppet

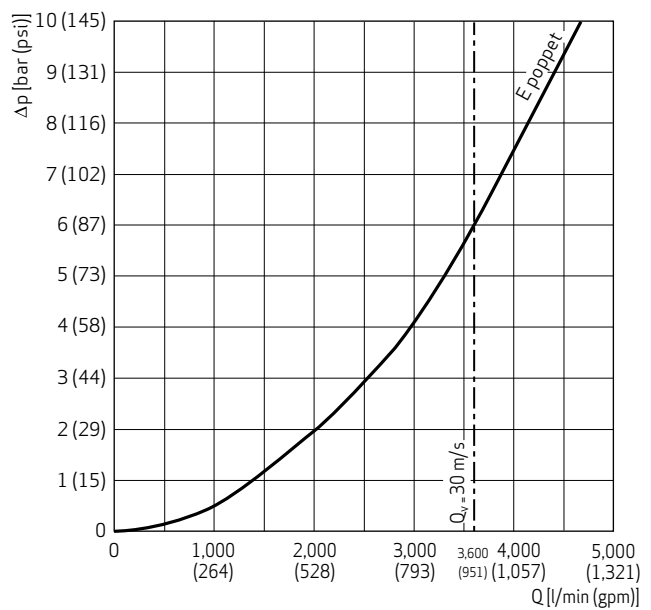

Notes

- Characteristic curves for pressure relief functions are included in the relevant catalog.
- Cartridges with AO poppets should only be used for pressure control. For a pressure relief function it is important that the pressure in port X not greatly exceeds the pressure in port A, otherwise damage to the valve seat may occur.

SIZE 63 - DIRECTIONAL CONTROL

General Technical Data

Flow direction	A ↔ B
Mounting pattern	ISO 7368-BF-12-2-A
Weight	6.9 kg (15.2 lb)

Specific Hydraulic Data

With poppet type	BO/BX	CO/CX	EO/EX	FO/FX
Maximum operating pressure port A, B, X¹⁾	420 bar (6,000 psi)			
Pilot volume (area A_x)	133.79 cm ³ (8.1644 in ³)			
Control panel				
Poppet stroke	28 mm (1.1 in)			
Surface A_A	3,187 mm ² (4.94 in ²)	4,465 mm ² (6.92 in ²)		
Factor A _A	1			
Factor A _B	0.5	0.07		
Factor A _X	1.5	1.07		
Seal material/hydraulic fluid combination				
FKM	<ul style="list-style-type: none"> Mineral oil based hydraulic fluids HFD hydraulic fluids 			
NBR	<ul style="list-style-type: none"> Mineral oil based hydraulic fluids HFB, HFC hydraulic fluids 			
Temperature range of hydraulic fluids				
Valve with FKM seals	-20 to +80 °C (-4 to 176 °F)			
Valve with NBR seals	-30 to +80 °C (-22 to 176 °F)			

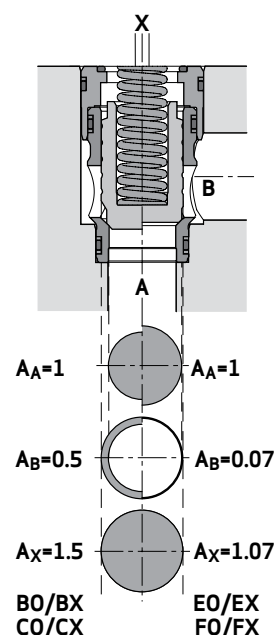

1) Please regard the maximum operating pressure of control cover and pilot valve.

Preferred Slip-in Cartridge Valve Types

With poppet type	Spring strength	Product code	Part number
BO	Spring S - 1.0 bar (15 psi)	N-CEE63K6BOS/KOB	X731-063BOS-000N00
BO	Spring T - 2.0 bar (29 psi)	N-CEE63K6BOT/KOB	X731-063BOT-000N00
BO	Spring U - 4.0 bar (58 psi)	N-CEE63K6BOU/KOB	X731-063BOU-000N00
BX	Spring U - 4.0 bar (58 psi)	N-CEE63K6BXU/KOB	X731-063BXU-000N00
CO	Spring S - 1.0 bar (10 psi)	N-CEE63K6COS/KOB	X731-063COS-000N00
CO	Spring T - 2.0 bar (29 psi)	N-CEE63K6COT/KOB	X731-063COT-000N00
CO	Spring U - 4.0 bar (58 psi)	N-CEE63K6COU/KOB	X731-063COU-000N00
CX	Spring U - 4.0 bar (58 psi)	N-CEE63K6CXU/KOB	X731-063CXU-000N00
EO	Spring S - 0.7 bar (10 psi)	N-CEE63K6EOS/KOB	X731-063EOS-000N00
EO	Spring T - 1.4 bar (20 psi)	N-CEE63K6EOT/KOB	X731-063EOT-000N00
EO	Spring U - 2.9 bar (42 psi)	N-CEE63K6EOU/KOB	X731-063EOU-000N00
EX	Spring U - 2.9 bar (42 psi)	N-CEE63K6EXU/KOB	X731-063EXU-000N00
FO	Spring S - 0.7 bar (10 psi)	N-CEE63K6FOS/KOB	X731-063FOS-000N00
FO	Spring T - 1.4 bar (20 psi)	N-CEE63K6FOT/KOB	X731-063FOT-000N00
FO	Spring U - 2.9 bar (42 psi)	N-CEE63K6FOU/KOB	X731-063FOU-000N00
FX	Spring U - 2.9 bar (42 psi)	N-CEE63K6FXU/KOB	X731-063FXU-000N00

SIZE 63 - DIRECTIONAL CONTROL

Hydraulic Symbol

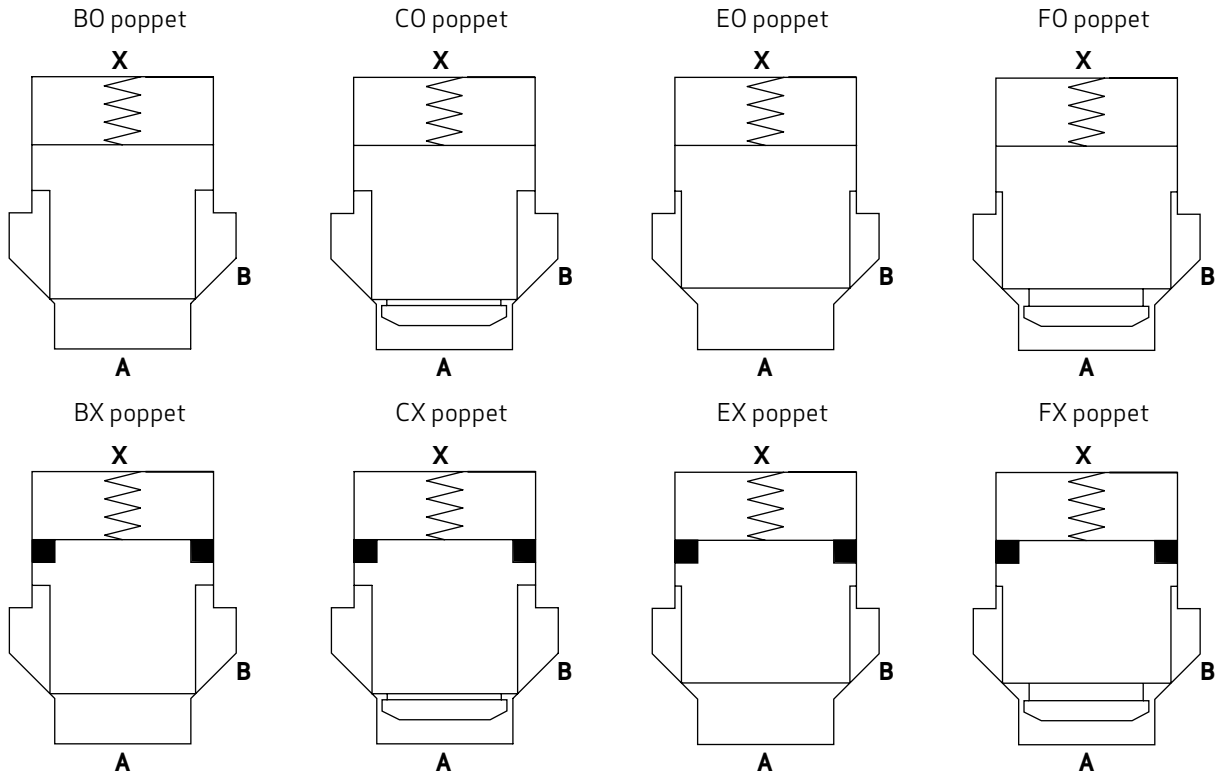

Valve Flow Diagram

Simulation conditions: Oil viscosity 32 mm²/s (cSt), oil temperature 40 °C (104 °F), port B drilled with d_{max} as per ISO 7368, valve fully opened

BO/BX, CO/CX poppet

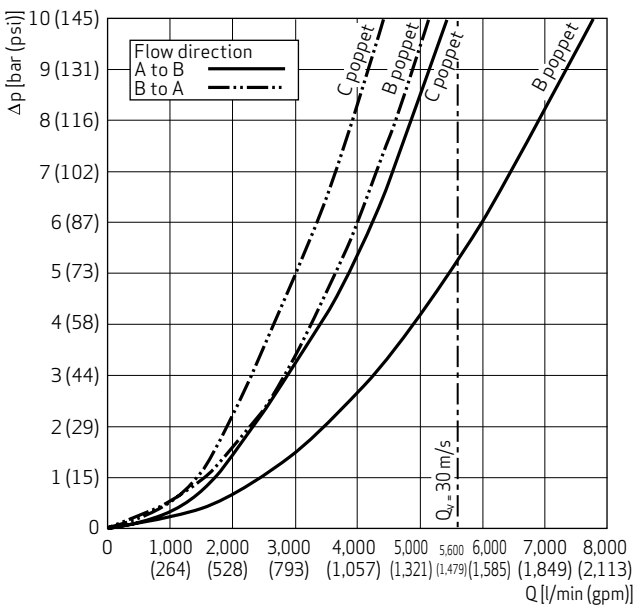

EO/EX, FO/FX poppet

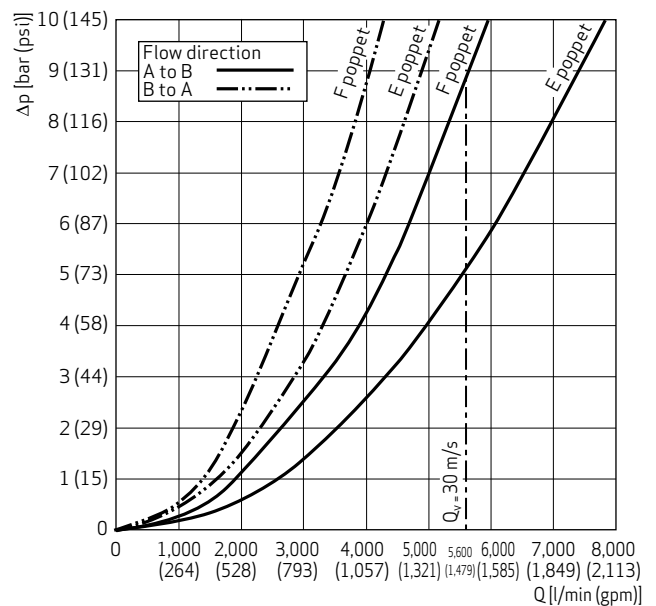

SIZE 63 - PRESSURE CONTROL

General Technical Data

Flow direction	A → B
Mounting pattern	ISO 7368-BF-12-2-A
Weight	6.9 kg (15.2 lb)
Orifice thread size (K99 poppet only)	M8

Specific Hydraulic Data

With poppet type	AO	EX
Maximum operating pressure port A, B, X¹⁾	420 bar (6,000 psi)	
Pilot volume (area A_x)	123.7 cm ³ (7.54 in ³)	133.79 cm ³ (8.16 in ³)
Control panel		
Poppet stroke	28 mm (1.1 in)	
Surface A_A	4,418 mm ² (6.85 in ²)	4,465 mm ² (6.92 in ²)
Factor A _A	1	
Factor A _B	0	0.07
Factor A _X	1	1.07
Seal material/hydraulic fluid combination		
FKM	<ul style="list-style-type: none"> Mineral oil based hydraulic fluids HFD hydraulic fluids 	
NBR	<ul style="list-style-type: none"> Mineral oil based hydraulic fluids HFB, HFC hydraulic fluids 	
Temperature range of hydraulic fluids		
Valve with FKM seals	-20 to +80 °C (-4 to 176 °F)	
Valve with NBR seals	-30 to +80 °C (-22 to 176 °F)	

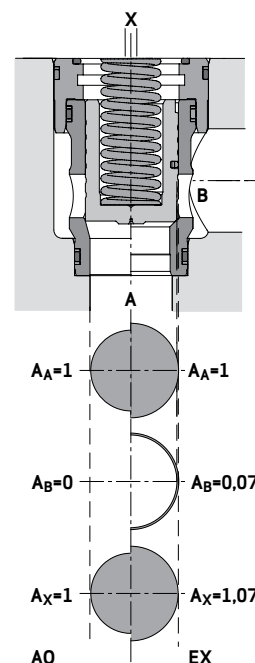

1) Please regard the maximum operating pressure of control cover and pilot valve.

Preferred Slip-in Cartridge Valve Types

With poppet type	Spring strength	Product code	Part number
AO/KOB	Spring S - 0.7 bar (10 psi)	N-CEE63K6AOS/KOB	X731-063AOS-000N00
AO/KOB	Spring T - 1.5 bar (22 psi)	N-CEE63K6AOT/KOB	X731-063AOT-000N00
AO/KOB	Spring U - 2.9 bar (42 psi)	N-CEE63K6AOU/KOB	X731-063AOU-000N00
AO/K99	Spring S - 0.7 bar (10 psi)	N-CEE63K6AOS/K99	X731-063AOS-001N00
AO/K99	Spring T - 1.5 bar (22 psi)	N-CEE63K6AOT/K99	X731-063AOT-001N00
AO/K99	Spring U - 2.9 bar (42 psi)	N-CEE63K6AOU/K99	X731-063AOU-001N00
EX/KOB	Spring U - 2.9 bar (42 psi)	N-CEE63K6EXU/KOB	X731-063EXU-000N00
EX/K99	Spring U - 2.9 bar (42 psi)	N-CEE63K6EXU/K99	X731-063EXU-001N00

SIZE 63 - PRESSURE CONTROL

Hydraulic Symbol

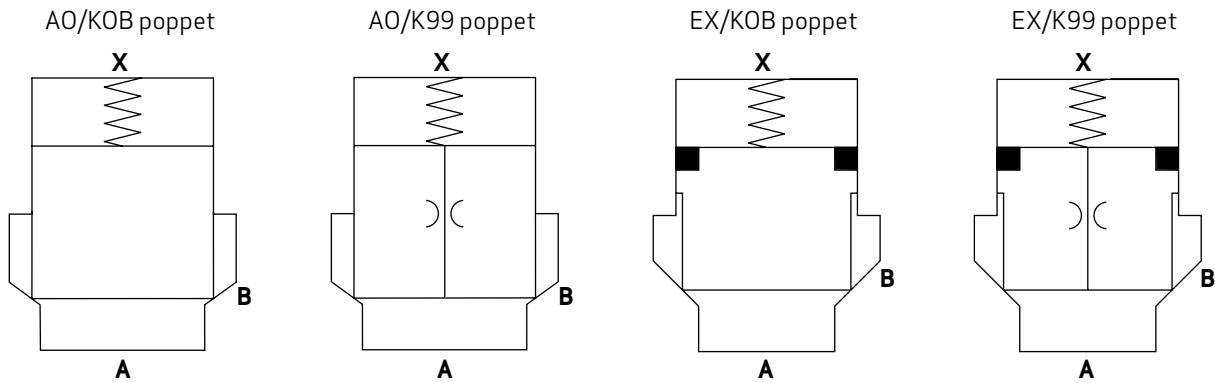

Valve Flow Diagram

Simulation conditions: Oil viscosity 32 mm²/s (cSt), oil temperature 40 °C (104°F), flow A→B, port B drilled with d4_{max} as per ISO 7368, valve fully opened

AO poppets

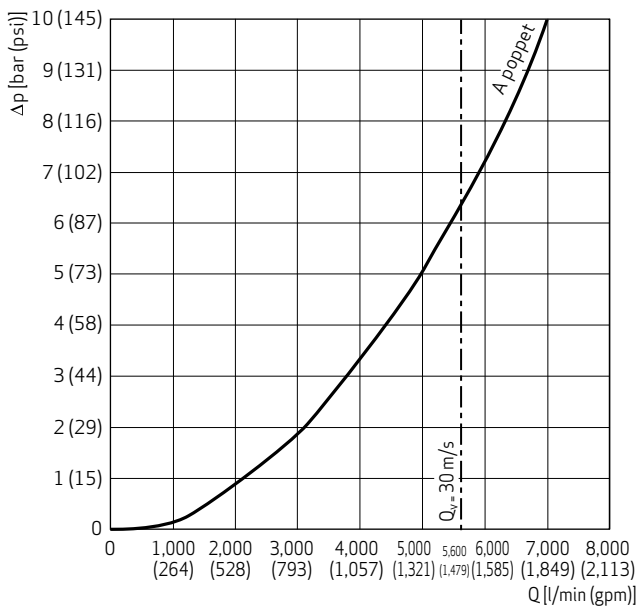

EX poppet

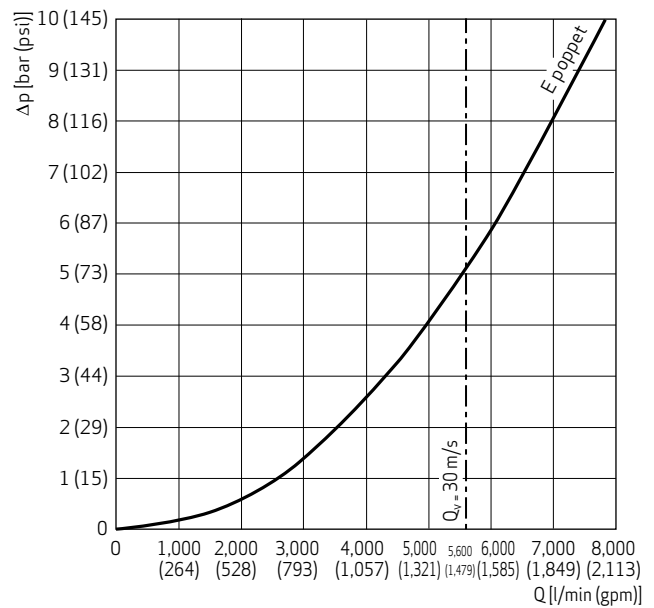

Notes

- Characteristic curves for pressure relief functions are included in the relevant catalog.
- Cartridges with AO poppets should only be used for pressure control. For a pressure relief function it is important that the pressure in port X not greatly exceeds the pressure in port A, otherwise damage to the valve seat may occur.

SIZE 80 - DIRECTIONAL CONTROL

General Technical Data

Flow direction	A ↔ B
Mounting pattern	ISO 7368-BG-13-2-A
Weight	12 kg (26.5 lb)

Specific Hydraulic Data

With poppet type	BO/BX	CO/CX	EO/EX	FO/FX
Maximum operating pressure port A, B, X¹⁾	420 bar (6,000 psi)			
Pilot volume (area A_X)	203.58 cm ³ (12.42 in ³)			
Control panel				
Poppet stroke	32 mm (1.26 in)			
Surface A_A	4,243 mm ² (6.58 in ²)	5,945 mm ² (9.21 in ²)		
Factor A _A	1			
Factor A _B	0.5	0.07		
Factor A _X	1.5	1.07		
Seal material/hydraulic fluid combination				
FKM	<ul style="list-style-type: none"> Mineral oil based hydraulic fluids HFD hydraulic fluids 			
NBR	<ul style="list-style-type: none"> Mineral oil based hydraulic fluids HFB, HFC hydraulic fluids 			
Temperature range of hydraulic fluids				
Valve with FKM seals	-20 to +80 °C (-4 to 176 °F)			
Valve with NBR seals	-30 to +80 °C (-22 to 176 °F)			

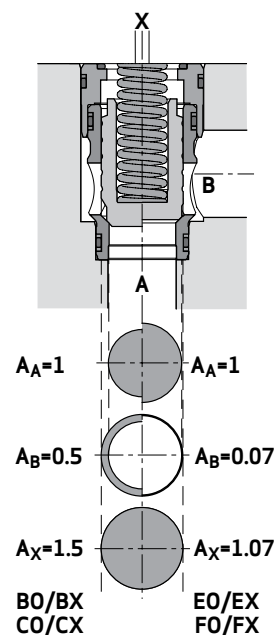

1) Please regard the maximum operating pressure of control cover and pilot valve.

Preferred Slip-in Cartridge Valve Types

With poppet type	Spring strength	Product code	Part number
BO	Spring S - 1.0 bar (15 psi)	N-CEE80K6BOS/KOB	X731-080BOS-000N00
BO	Spring T - 2.0 bar (29 psi)	N-CEE80K6BOT/KOB	X731-080BOT-000N00
BO	Spring U - 4.0 bar (58 psi)	N-CEE80K6BOU/KOB	X731-080BOU-000N00
BX	Spring U - 4.0 bar (58 psi)	N-CEE80K6BXU/KOB	X731-080BXU-000N00
CO	Spring S - 1.0 bar (15 psi)	N-CEE80K6COS/KOB	X731-080COS-000N00
CO	Spring T - 2.0 bar (29 psi)	N-CEE80K6COT/KOB	X731-080COT-000N00
CO	Spring U - 4.0 bar (58 psi)	N-CEE80K6COU/KOB	X731-080COU-000N00
CX	Spring U - 4.0 bar (58 psi)	N-CEE80K6CXU/KOB	X731-080CXU-000N00
EO	Spring S - 0.7 bar (10 psi)	N-CEE80K6EOS/KOB	X731-080EOS-000N00
EO	Spring T - 1.4 bar (20 psi)	N-CEE80K6EOT/KOB	X731-080EOT-000N00
EO	Spring U - 2.8 bar (41 psi)	N-CEE80K6EOU/KOB	X731-080EOU-000N00
EX	Spring U - 2.8 bar (41 psi)	N-CEE80K6EXU/KOB	X731-080EXU-000N00
FO	Spring S - 0.7 bar (10 psi)	N-CEE80K6FOS/KOB	X731-080FOS-000N00
FO	Spring T - 1.4 bar (20 psi)	N-CEE80K6FOT/KOB	X731-080FOT-000N00
FO	Spring U - 2.8 bar (41 psi)	N-CEE80K6FOU/KOB	X731-080FOU-000N00
FX	Spring U - 2.8 bar (41 psi)	N-CEE80K6FXU/KOB	X731-080FXU-000N00

SIZE 80 - DIRECTIONAL CONTROL

Hydraulic Symbol

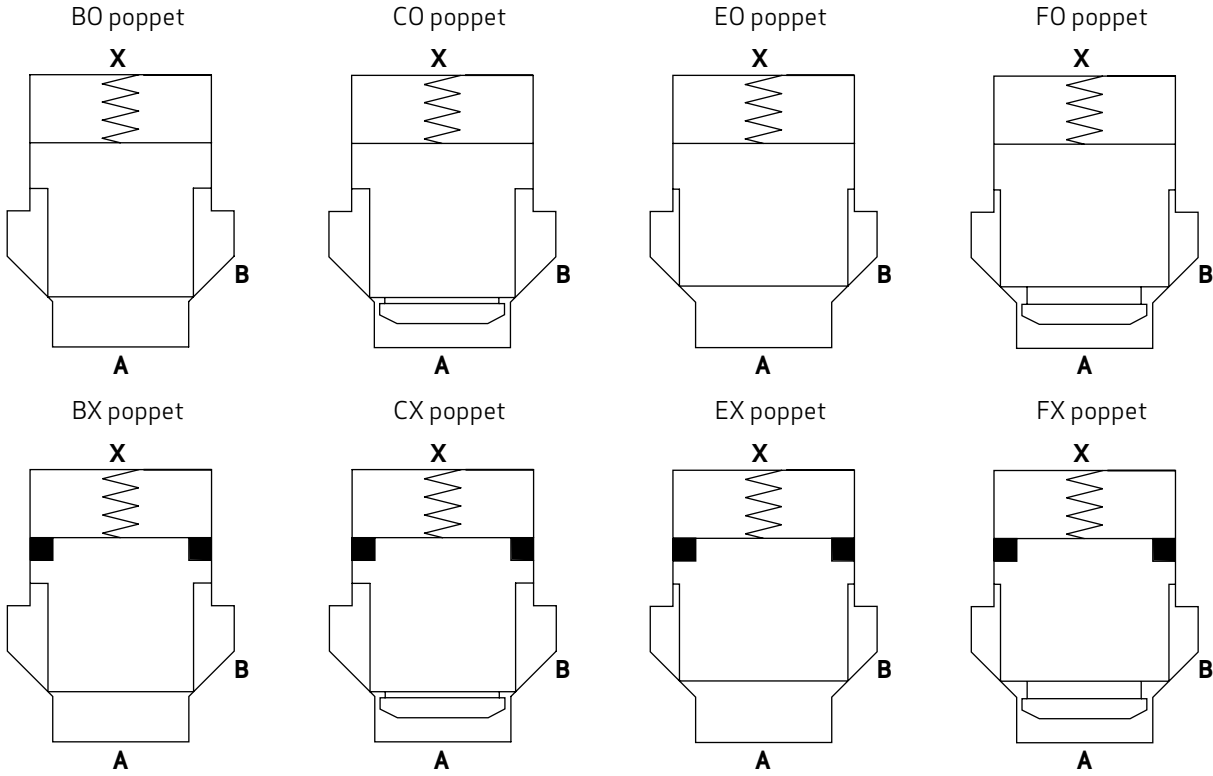

Valve Flow Diagram

Simulation conditions: Oil viscosity 32 mm²/s (cSt), oil temperature 40 °C (104 °F), port B drilled with d_{max} as per ISO 7368, valve fully opened

BO/BX, CO/CX poppet

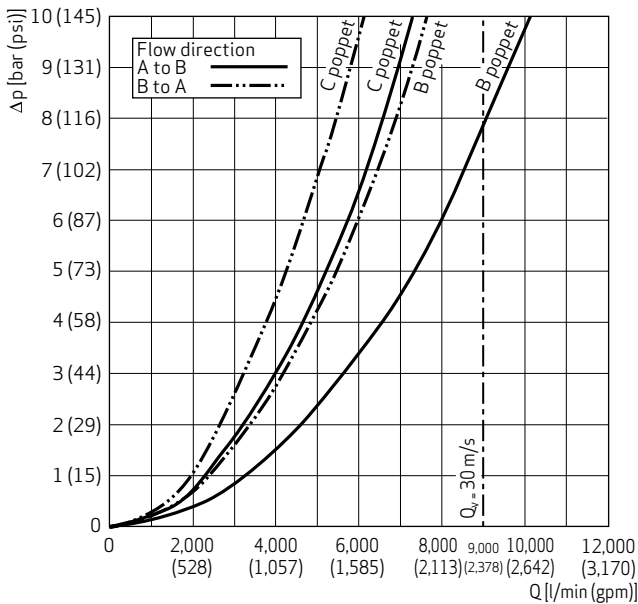

EO/EX, FO/FX poppet

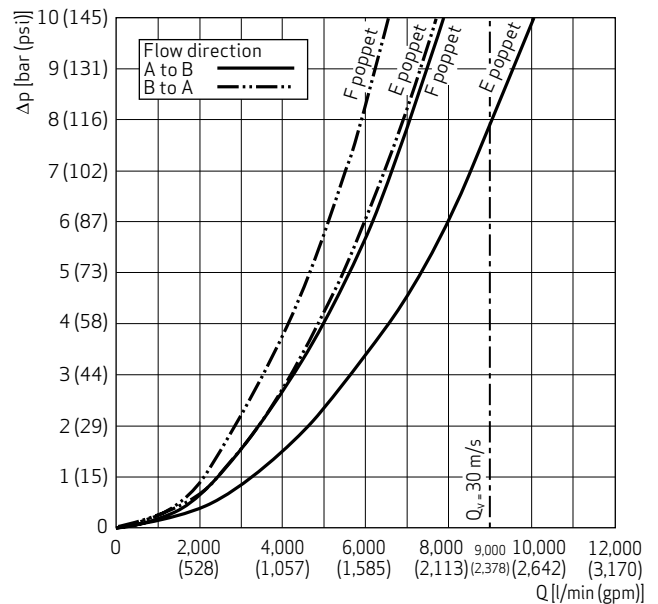

SIZE 80 - PRESSURE CONTROL

General Technical Data

Flow direction	A → B
Mounting pattern	ISO 7368-BG-13-2-A
Weight	12 kg
Orifice thread size (K99 poppet only)	M8

Specific Hydraulic Data

With poppet type	AO	EX
Maximum operating pressure port A, B, X ¹⁾	420 bar (6,000 psi)	
Pilot volume (area A_x)	190.23 cm ³ (11.60 in ³)	203.58 cm ³ (12.42 in ³)
Control panel		
Poppet stroke	32 mm (1.26 in)	
Surface A_A	5,945 mm ² (9.21 in ²)	
Factor A _A	1	
Factor A _B	0	0.07
Factor A _x	1	1.07
Seal material/hydraulic fluid combination		
FKM	<ul style="list-style-type: none"> Mineral oil based hydraulic fluids HFD hydraulic fluids 	
NBR	<ul style="list-style-type: none"> Mineral oil based hydraulic fluids HFB, HFC hydraulic fluids 	
Temperature range of hydraulic fluids		
Valve with FKM seals	-20 to +80 °C (-4 to 176 °F)	
Valve with NBR seals	-30 to +80 °C (-22 to 176 °F)	

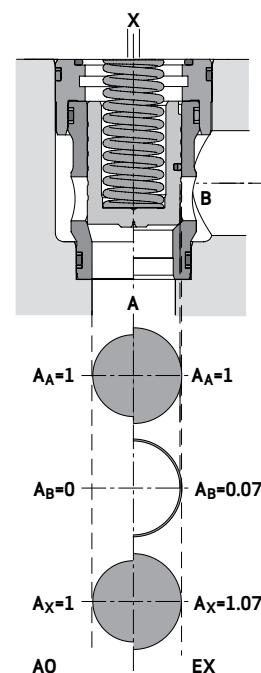

1) Please regard the maximum operating pressure of control cover and pilot valve.

Preferred Slip-in Cartridge Valve Types

With poppet type	Spring strength	Product code	Part number
AO/KOB	Spring S - 0.7 bar (10 psi)	N-CEE80K6AOS/KOB	X731-080AOS-000N00
AO/KOB	Spring T - 1.4 bar (20 psi)	N-CEE80K6AOT/KOB	X731-080AOT-000N00
AO/KOB	Spring U - 2.8 bar (41 psi)	N-CEE80K6AOU/KOB	X731-080AOU-000N00
AO/K99	Spring S - 0.7 bar (10 psi)	N-CEE80K6AOS/K99	X731-080AOS-001N00
AO/K99	Spring T - 1.4 bar (20 psi)	N-CEE80K6AOT/K99	X731-080AOT-001N00
AO/K99	Spring U - 2.8 bar (41 psi)	N-CEE80K6AOU/K99	X731-080AOU-001N00
EX/KOB	Spring U - 2.8 bar (41 psi)	N-CEE80K6EXU/KOB	X731-080EXU-000N00
EX/K99	Spring U - 2.8 bar (41 psi)	N-CEE80K6EXU/K99	X731-080EXU-001N00

SIZE 80 - PRESSURE CONTROL

Hydraulic Symbol

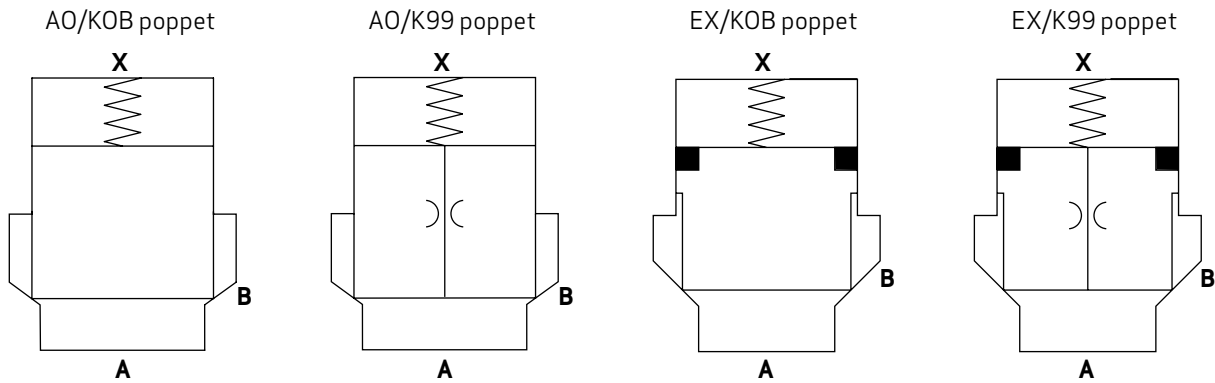

Valve Flow Diagram

Simulation conditions: Oil viscosity 32 mm²/s (cSt), oil temperature 40 °C (104 °F), flow A→B, port B drilled with d4_{max} as per ISO 7368, valve fully opened

AO poppets

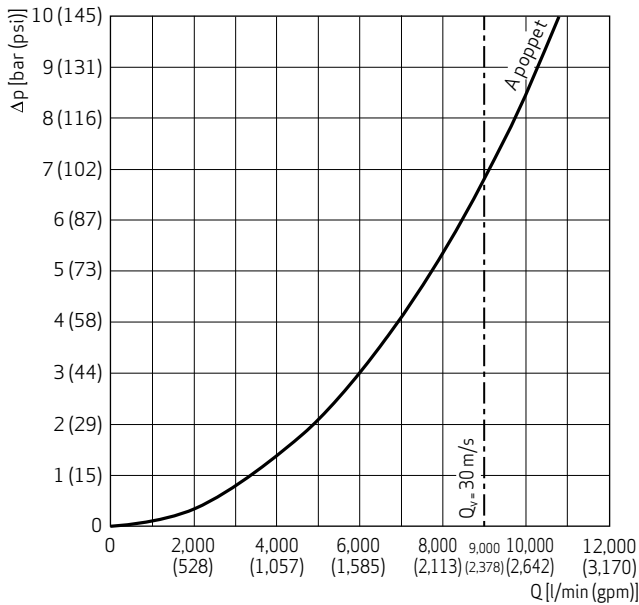

EX poppet

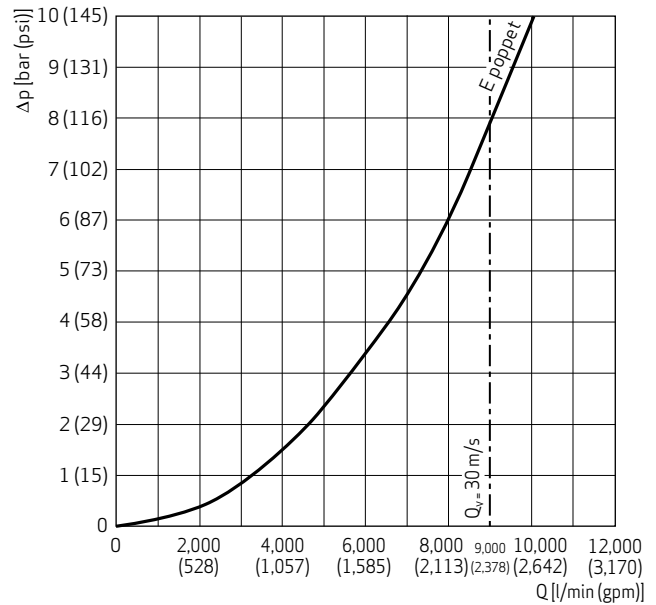

Notes

- Characteristic curves for pressure relief functions are included in the relevant catalog.
- Cartridges with AO poppets should only be used for pressure control. For a pressure relief function it is important that the pressure in port X not greatly exceeds the pressure in port A, otherwise damage to the valve seat may occur.

SIZE 100 - DIRECTIONAL CONTROL

General Technical Data

Flow direction	A ↔ B
Mounting pattern	ISO 7368-BH-14-2-A
Weight	24 kg (52.9 lb)

Specific Hydraulic Data

With poppet type	BO/BX	CO/CX	EO/EX	FO/FX
Maximum operating pressure port A, B, X¹⁾	420 bar (6,000 psi)			
Pilot volume (area A_x)	444.21 cm ³ (27.10 in ³)			
Control panel				
Poppet stroke	38 mm (1.5 in)			
Surface A_A	7,791 mm ² (12.08 in ²)	10,936 mm ² (16.95 in ²)		
Factor A _A	1			
Factor A _B	0.5	0.07		
Factor A _x	1.5	1.07		
Seal material/hydraulic fluid combination				
FKM	<ul style="list-style-type: none"> Mineral oil based hydraulic fluids HFD hydraulic fluids 			
NBR	<ul style="list-style-type: none"> Mineral oil based hydraulic fluids HFB, HFC hydraulic fluids 			
Temperature range of hydraulic fluids				
Valve with FKM seals	-20 to +80 °C (-4 to 176 °F)			
Valve with NBR seals	-30 to +80 °C (-22 to 176 °F)			

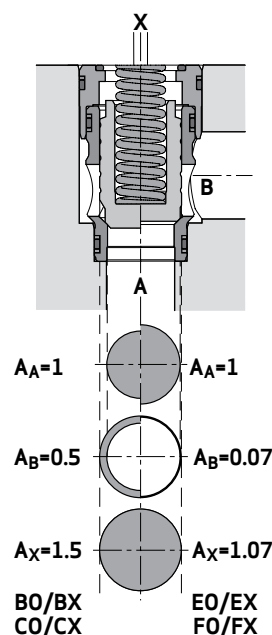

1) Please regard the maximum operating pressure of control cover and pilot valve.

Preferred Slip-in Cartridge Valve Types

With poppet type	Spring strength	Product code	Part number
BO	Spring S - 1.0 bar (15 psi)	N-CEE100K6BOS/KOB	X731-100BOS-000N00
BO	Spring T - 2.0 bar (29 psi)	N-CEE100K6BOT/KOB	X731-100BOT-000N00
BO	Spring U - 4.0 bar (58 psi)	N-CEE100K6BOU/KOB	X731-100BOU-000N00
BX	Spring U - 4.0 bar (58 psi)	N-CEE100K6BXU/KOB	X731-100BXU-000N00
CO	Spring S - 1.0 bar (15 psi)	N-CEE100K6COS/KOB	X731-100COS-000N00
CO	Spring T - 2.0 bar (29 psi)	N-CEE100K6COT/KOB	X731-100COT-000N00
CO	Spring U - 4.0 bar (58 psi)	N-CEE100K6COU/KOB	X731-100COU-000N00
CX	Spring U - 4.0 bar (58 psi)	N-CEE100K6CXU/KOB	X731-100CXU-000N00
EO	Spring S - 0.7 bar (10 psi)	N-CEE100K6EOS/KOB	X731-100EOS-000N00
EO	Spring T - 1.4 bar (20 psi)	N-CEE100K6EOT/KOB	X731-100EOT-000N00
EO	Spring U - 2.8 bar (41 psi)	N-CEE100K6EOU/KOB	X731-100EOU-000N00
EX	Spring U - 2.8 bar (41 psi)	N-CEE100K6EXU/KOB	X731-100EXU-000N00
FO	Spring S - 0.7 bar (10 psi)	N-CEE100K6FOS/KOB	X731-100FOS-000N00
FO	Spring T - 1.4 bar (20 psi)	N-CEE100K6FOT/KOB	X731-100FOT-000N00
FO	Spring U - 2.8 bar (41 psi)	N-CEE100K6FOU/KOB	X731-100FOU-000N00
FX	Spring U - 2.8 bar (41 psi)	N-CEE100K6FXU/KOB	X731-100FXU-000N00

SIZE 100 - DIRECTIONAL CONTROL

Hydraulic Symbol

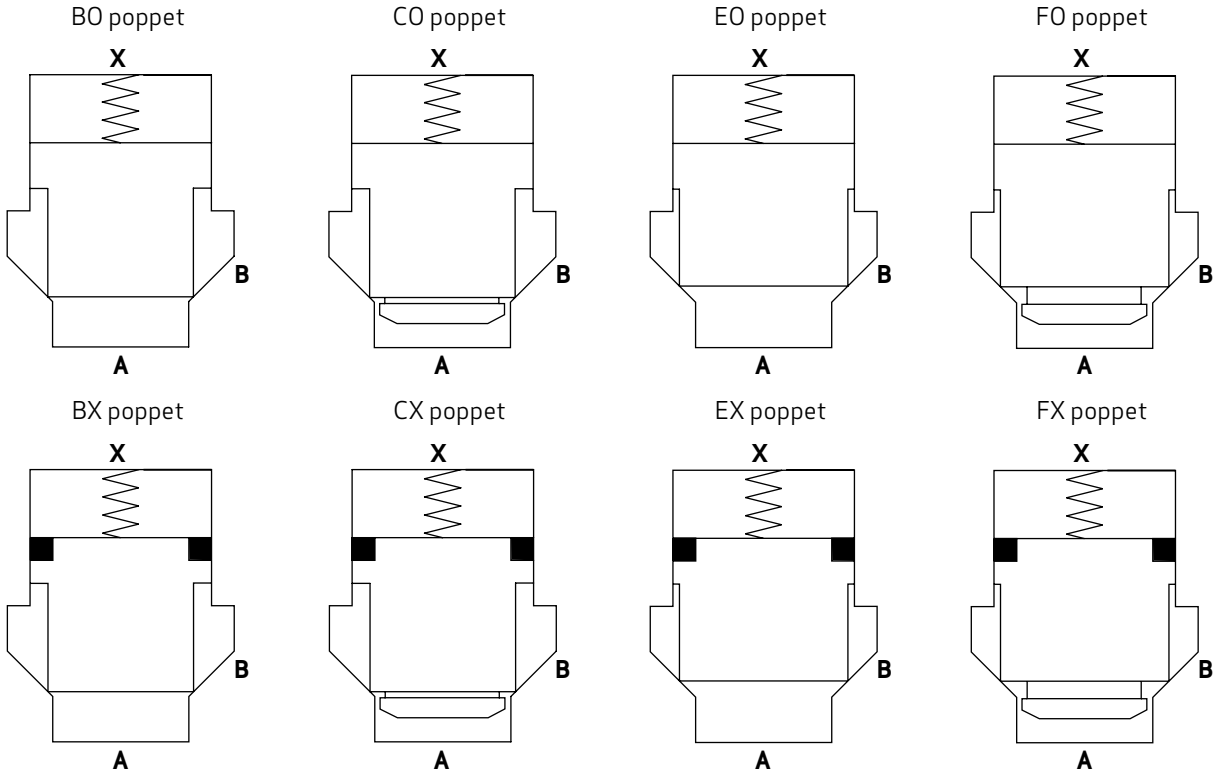

Valve Flow Diagram

Simulation conditions: Oil viscosity 32 mm²/s (cSt), oil temperature 40 °C (104 °F), port B drilled with d_{max} as per ISO 7368, valve fully opened

BO/BX, CO/CX poppet

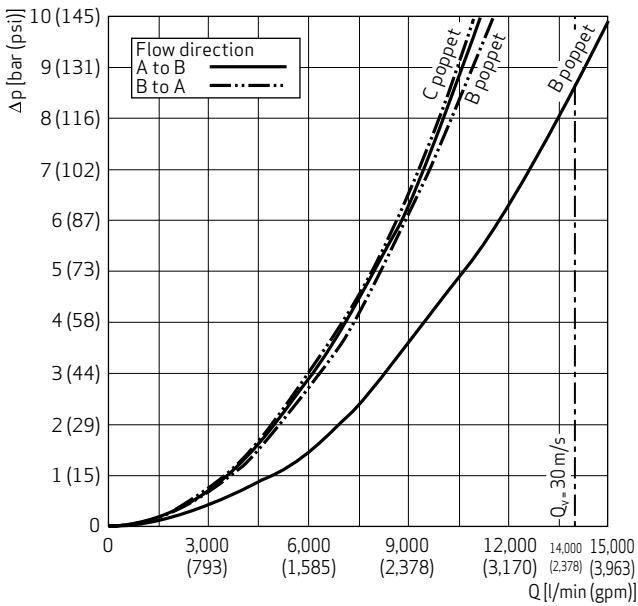

EO/EX, FO/FX poppet

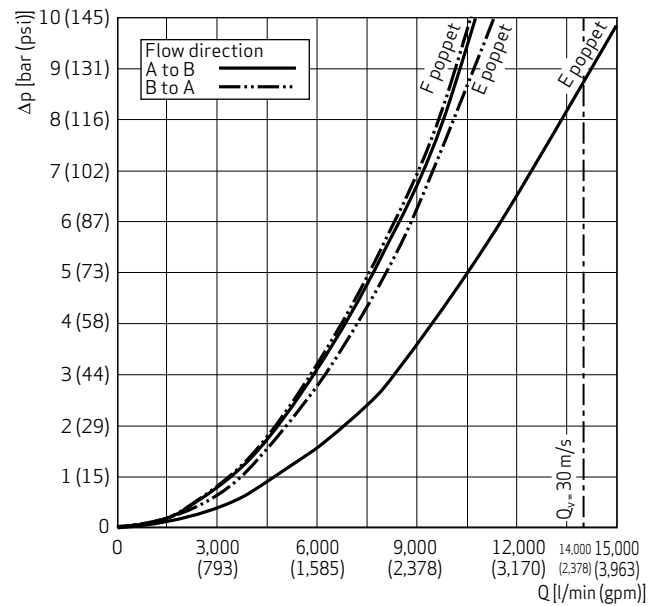

SIZE 100 - PRESSURE CONTROL

General Technical Data

Flow direction	A → B
Mounting pattern	ISO 7368-BH-14-2-A
Weight	24 kg (52.9 lb)
Orifice thread size (K99 poppet only)	M8

Specific Hydraulic Data

With poppet type	AO	EX
Maximum operating pressure port A, B, X ¹⁾	420 bar (6,000 psi)	
Pilot volume (area A_x)	393.69 cm ³ (24.02 in ³)	444.21 cm ³ (27.10 in ³)
Control panel		
Poppet stroke	36 mm (1.42 in)	38 mm (1.5 in)
Surface A_A	10,936 mm ² (16.95 in ²)	
Factor A _A	1	
Factor A _B	0	0.07
Factor A _x	1	1.07
Seal material/hydraulic fluid combination		
FKM	<ul style="list-style-type: none"> Mineral oil based hydraulic fluids HFD hydraulic fluids 	
NBR	<ul style="list-style-type: none"> Mineral oil based hydraulic fluids HFB, HFC hydraulic fluids 	
Temperature range of hydraulic fluids		
Valve with FKM seals	-20 to +80 °C (-4 to 176 °F)	
Valve with NBR seals	-30 to +80 °C (-22 to 176 °F)	

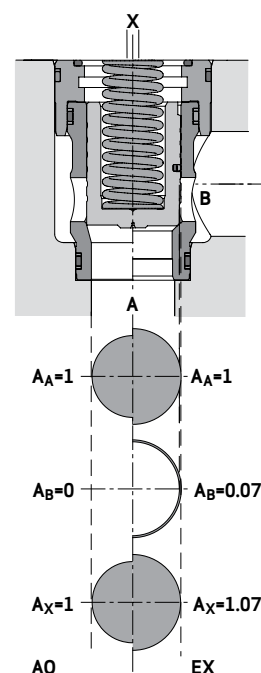

1) Please regard the maximum operating pressure of control cover and pilot valve.

Preferred Slip-in Cartridge Valve Types

With poppet type	Spring strength	Product code	Part number
AO/KOB	Spring S - 0.7 bar (10 psi)	N-CEE100K6AOS/KOB	X731-100AOS-000N00
AO/KOB	Spring T - 1.4 bar (20 psi)	N-CEE100K6AOT/KOB	X731-100AOT-000N00
AO/KOB	Spring U - 2.8 bar (41 psi)	N-CEE100K6AOU/KOB	X731-100AOU-000N00
AO/K99	Spring S - 0.7 bar (10 psi)	N-CEE100K6AOS/K99	X731-100AOS-001N00
AO/K99	Spring T - 1.4 bar (20 psi)	N-CEE100K6AOT/K99	X731-100AOT-001N00
AO/K99	Spring U - 2.8 bar (41 psi)	N-CEE100K6AOU/K99	X731-100AOU-001N00
EX/KOB	Spring U - 2.8 bar (41 psi)	N-CEE100K6EXU/KOB	X731-100EXU-000N00
EX/K99	Spring U - 2.8 bar (41 psi)	N-CEE100K6EXU/K99	X731-100EXU-001N00

SIZE 100 - PRESSURE CONTROL

Hydraulic Symbol

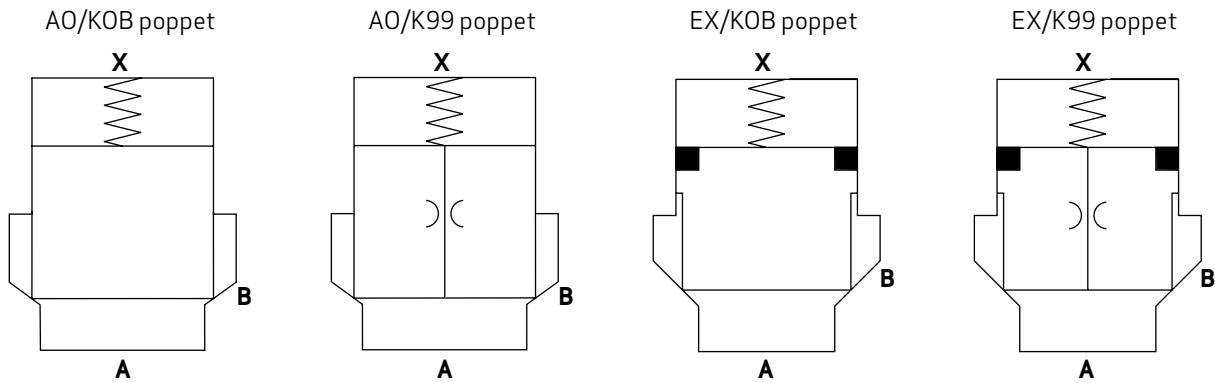

Valve Flow Diagram

Simulation conditions: Oil viscosity 32 mm²/s (cSt), oil temperature 40 °C (104 °F), flow A→B, port B drilled with d4_{max} as per ISO 7368, valve fully opened

AO poppets

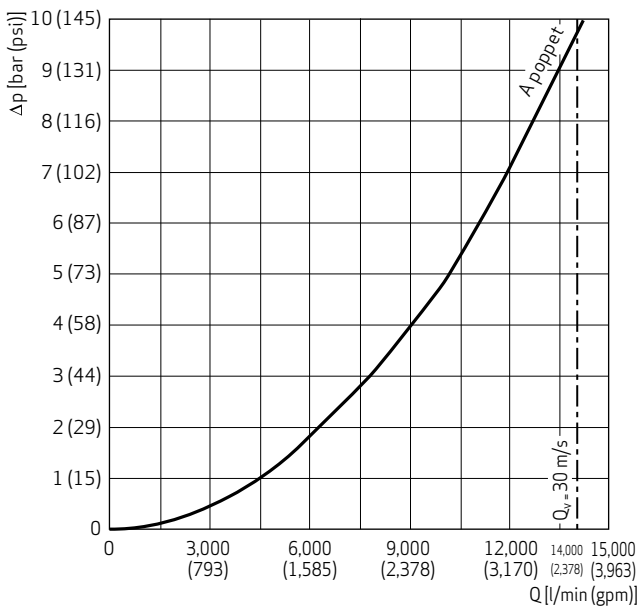

EX poppet

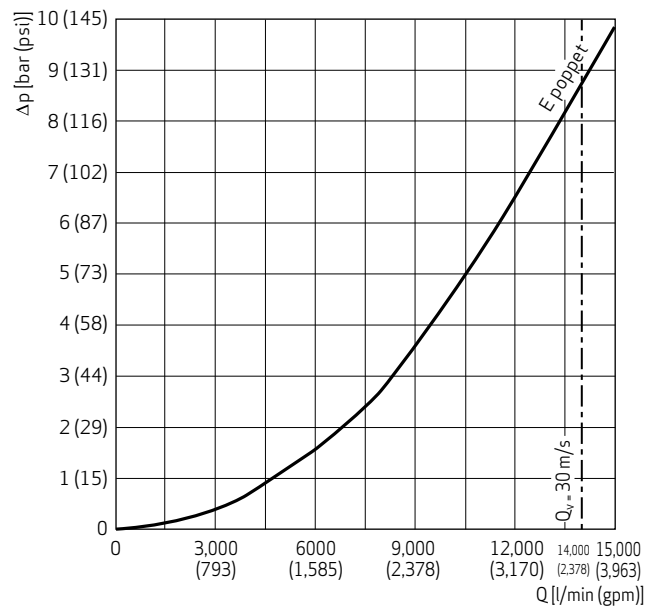

Notes

- Characteristic curves for pressure relief functions are included in the relevant catalog.
- Cartridges with AO poppets should only be used for pressure control. For a pressure relief function it is important that the pressure in port X not greatly exceeds the pressure in port A, otherwise damage to the valve seat may occur.

INSTALLATION DIMENSIONS

In Accordance with ISO 7386:1989-08

Cartridge Cavity

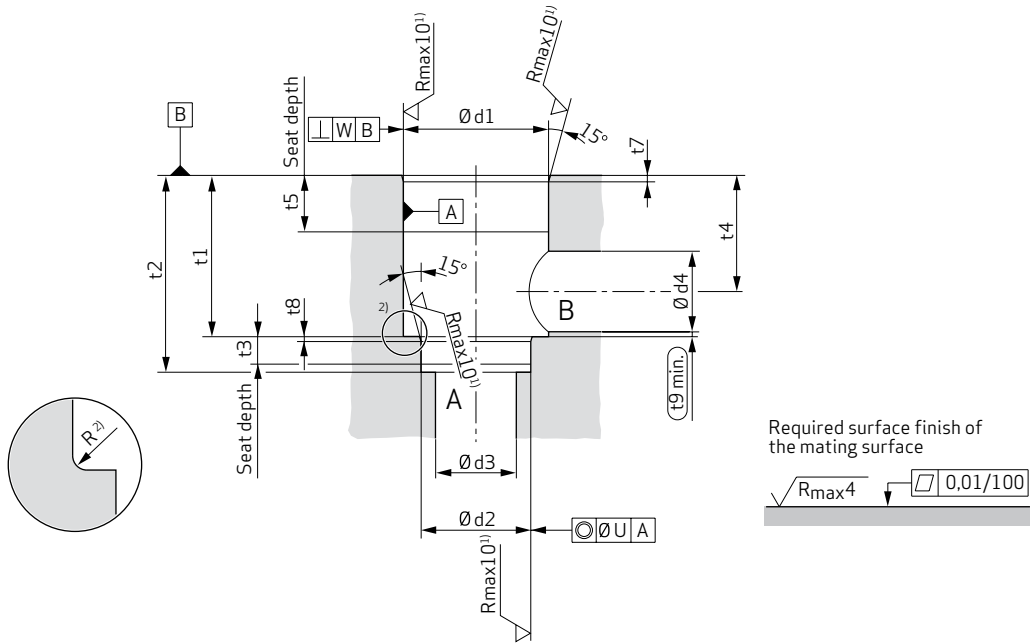

- 1) Recommendation deviates from the standard
- 2) For operating pressure greater than 350 bar (5,000 psi) Moog recommends a flanging radius of R 1.2 mm for Sizes 16 to 32 and R 4 mm for Sizes 40 to 100 deviating from ISO 7368

Bolt and Port Pattern

Sizes 16 to 63

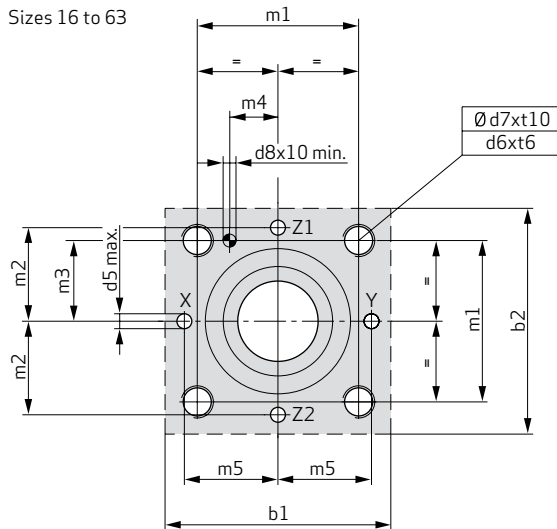

Sizes 80 and 100

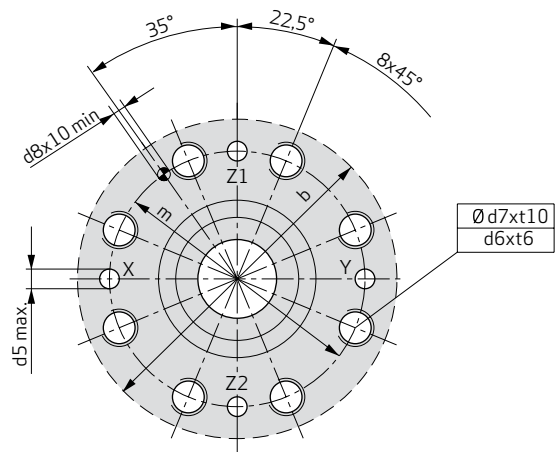

INSTALLATION DIMENSIONS

In Accordance with ISO 7386:1989-08

ND	16 mm	25 mm	32 mm	40 mm	50 mm	63 mm
b1	65 (2.56)	85 (3.35)	102 (4.02)	125 (4.92)	140 (5.51)	200 (7.87)
b2	65 (2.56)	85 (3.35)	102 (4.02)	125 (4.92)	140 (5.51)	180 (7.09)
d1^{H7 1)}	32 (1.26)	45 (1.77)	60 (2.36)	75 (2.95)	90 (3.54)	120 (4.72)
d2^{H7 1)}	35 (1.38)	34 (1.34)	45 (1.77)	55 (2.17)	68 (2.68)	90 (3.54)
d3	16 (0.63)	25 (0.98)	32 (1.26)	40 (1.57)	50 (1.97)	63 (2.48)
d4	16 (0.63)	25 (0.98)	32 (1.26)	40 (1.57)	50 (1.97)	63 (2.48)
d4_{max.}¹⁾	25 (0.98)	32 (1.26)	40 (1.57)	50 (1.97)	63 (2.48)	80 (3.15)
d5_{max.}	4 (0.16)	6 (0.24)	8 (0.31)	10 (0.39)	10 (0.39)	12 (0.47)
d6	M8	M12	M16	M20	M20	M30
d7	6.8 (0.27)	10.2 (0.4)	14 (0.55)	17.5 (0.69)	17.5 (0.69)	26.5 (1.04)
d8^{H13}	4 (0.16)	6 (0.24)	6 (0.24)	6 (0.24)	8 (0.31)	8 (0.31)
m1^{±0.2}	46 (1.81)	58 (2.28)	70 (2.76)	85 (3.35)	100 (3.94)	125 (4.92)
m2^{±0.2}	25 (0.98)	33 (1.3)	41 (1.61)	50 (1.97)	58 (2.28)	75 (2.95)
m3^{±0.2}	23 (0.91)	29 (1.14)	35 (1.38)	42.5 (1.67)	50 (1.97)	62.5 (2.46)
m4^{±0.2}	10.5 (0.41)	16 (0.63)	17 (0.67)	23 (0.91)	30 (1.18)	38 (1.5)
m5^{±0.2}	25 (0.98)	33 (1.3)	41 (1.61)	50 (1.97)	58 (2.28)	75 (2.95)
t1^{+0.1}	43 (1.69)	58 (2.28)	70 (2.76)	87 (3.43)	100 (3.94)	130 (5.12)
t2^{+0.1}	56 (2.2)	72 (2.83)	85 (3.35)	105 (4.13)	122 (4.8)	155 (6.1)
t3	11 (0.43)	12 (0.47)	13 (0.51)	15 (0.59)	17 (0.67)	20 (0.79)
t4	34 (1.34)	44 (1.73)	52 (2.05)	64 (2.52)	72 (2.83)	95 (3.74)
t4 bei d4_{max.}¹⁾	29.5 (1.16)	40.5 (1.59)	48 (1.89)	59 (2.32)	65.5 (2.58)	86.5 (3.41)
t5	20 (0.79)	30 (1.18)	30 (1.18)	30 (1.18)	35 (1.38)	40 (1.57)
t6	14 (0.55)	20 (0.79)	26 (1.02)	33 (1.3)	33 (1.3)	50 (1.97)
t7	2 (0.08)	2.5 (0.1)	2.5 (0.1)	3 (0.12)	4 (0.16)	4 (0.16)
t8	2 (0.08)	2.5 (0.1)	2.5 (0.1)	3 (0.12)	3 (0.12)	4 (0.16)
t9	0.5 (0.02)	1.0 (0.04)	1.5 (0.06)	2.5 (0.1)	2.5 (0.1)	3 (0.12)
t10	17 (0.67)	24 (0.94)	31 (1.22)	38 (1.5)	38 (1.5)	56 (2.2)
U	0.03 (0)	0.03 (0)	0.03 (0)	0.05 (0)	0.05 (0)	0.05 (0)
W	0.05 (0)	0.05 (0)	0.1 (0)	0.1 (0)	0.1 (0)	0.2 (0.01)

ND	80 mm	100 mm
b_{max.}	250 (9.84)	300 (11.81)
d1^{H7 1)}	145 (5.71)	180 (7.09)
d2^{H7 1)}	110 (4.33)	135 (5.31)
d3	80 (3.15)	100 (3.94)
d4	80 (3.15)	100 (3.94)
d4_{max.}¹⁾	100 (3.94)	125 (4.92)
d5_{max.}	16 (0.63)	20 (0.79)
d6	M24	M30
d7	21 (0.83)	26.5 (1.04)
d8^{H13}	10 (0.39)	10 (0.39)
m^{±0.3}	200 (7.87)	245 (9.65)
t1	175 (6.89)	210 (8.27)
t2^{+0.2}	205 (8.07)	245 (9.65)
t3	25 (0.98)	29 (1.14)
t4	130 (5.12)	155 (6.1)
t4 bei d4_{max.}¹⁾	120 (4.72)	142.5 (5.61)
t5	40 (1.57)	50 (1.97)
t6	39 (1.54)	50 (1.97)
t7	5 (0.2)	5 (0.2)
t8	5 (0.2)	5 (0.2)
t9	3 (0.12)	5 (0.2)
t10	45 (1.77)	56 (2.2)
U	0.05 (0)	0.05 (0)
W	0.2 (0.01)	0.2 (0.01)

1) Recommendation deviates from the standard

Note: Dimensions in mm (in)

ACCESSORIES AND SPARE PARTS

Size Specific Accessories and Spare Parts

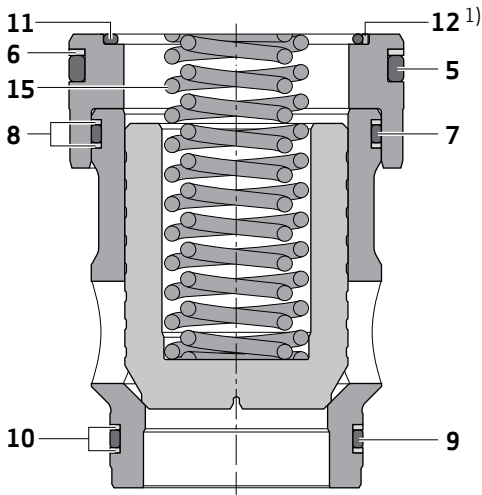

1) Valid for sizes 50 to 100

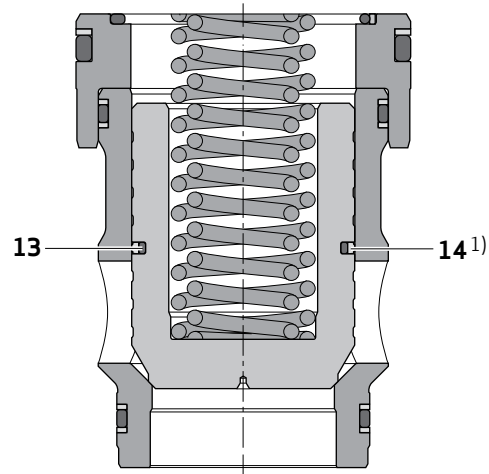

1) Appropriate assembly tools must be used to fit the shaft seal.

Size 16

Position	Part designation	Description	Part number
	Disassembly tool	X731-016	XEB19149-016-00
5	O-ring - 70 Shore	Ø 28.3x1.78 mm	
7	O-ring - 70 Shore	Ø 23.52x1.78 mm	
9	O-ring - 70 Shore	Ø 21.95x1.78 mm	
11	O-ring - 90 Shore	Ø 18.72x2.62 mm	
5, 6, 7, 8, 9, 10, 11	Seal kit NBR	N-CEE16K6_O_	X731-016_O_D000N00
5, 6, 7, 8, 9, 10, 11	Seal kit FKM	V-CEE16K6_O_	X731-016_O_D000V00
5, 6, 7, 8, 9, 10, 11, 13, 14	Seal kit NBR	N-CEE16K6_X_	X731-016_X_D000N00
5, 6, 7, 8, 9, 10, 11, 13, 14	Seal kit FKM	V-CEE16K6_X_	X731-016_X_D000V00
15	Spring R	CEE16K6	XE10513
15	Spring S	CEE16K6	XE10514
15	Spring T	CEE16K6	XE10515
15	Spring U	CEE16K6	XE10516

ACCESSORIES AND SPARE PARTS

Size 25

Position	Part designation	Description	Part number
	Disassembly tool	X731-025	XEB19149-025-00
5	O-ring - 70 Shore	Ø 39.34x2.62 mm	
7	O-ring - 70 Shore	Ø 34.59x2.62 mm	
9	O-ring - 70 Shore	Ø 28.24x2.62 mm	
11	O-ring - 90 Shore	Ø 28.24x2.62 mm	
5, 6, 7, 8, 9, 10, 11	Seal kit NBR	N-CEE25K6_O_	X731-025_O_D000N00
5, 6, 7, 8, 9, 10, 11	Seal kit FKM	V-CEE25K6_O_	X731-025_O_D000V00
5, 6, 7, 8, 9, 10, 11, 13, 14	Seal kit NBR	N-CEE25K6_X_	X731-025_X_D000N00
5, 6, 7, 8, 9, 10, 11, 13, 14	Seal kit FKM	V-CEE25K6_X_	X731-025_X_D000V00
15	Spring R	CEE25K6	XE10502
15	Spring S	CEE25K6	XE10503
15	Spring T	CEE25K6	XE10504
15	Spring U	CEE25K6	XE10505

Size 32

Position	Part designation	Description	Part number
	Disassembly tool	X731-032	XEB19149-032-00
5	O-ring - 70 Shore	Ø 53.57x3.53 mm	
7	O-ring - 70 Shore	Ø 44.04x3.53 mm	
9	O-ring - 70 Shore	Ø 39.34x2.62 mm	
11	O-ring - 90 Shore	Ø 40.87x3.53 mm	
5, 6, 7, 8, 9, 10, 11	Seal kit NBR	N-CEE32K6_O_	X731-032_O_D000N00
5, 6, 7, 8, 9, 10, 11	Seal kit FKM	V-CEE32K6_O_	X731-032_O_D000V00
5, 6, 7, 8, 9, 10, 11, 13, 14	Seal kit NBR	N-CEE32K6_X_	X731-032_X_D000N00
5, 6, 7, 8, 9, 10, 11, 13, 14	Seal kit FKM	V-CEE32K6_X_	X731-032_X_D000V00
15	Spring R	CEE32K6	XE10527
15	Spring S	CEE32K6	XE10528
15	Spring T	CEE32K6	XE10530
15	Spring U	CEE32K6	XE10531

ACCESSORIES AND SPARE PARTS

Size 40

Position	Part designation	Description	Part number
	Disassembly tool	X731-040	XEB19149-040-00
5	O-ring - 70 Shore	Ø 66.27x3.53 mm	
7	O-ring - 70 Shore	Ø 56.74x3.53 mm	
9	O-ring - 70 Shore	Ø 47.22x3.53 mm	
11	O-ring - 90 Shore	Ø 50.39x3.53 mm	
5, 6, 7, 8, 9, 10, 11	Seal kit NBR	N-CEE40K6_O_	X731-040_O_D000N00
5, 6, 7, 8, 9, 10, 11	Seal kit FKM	V-CEE40K6_O_	X731-040_O_D000V00
5, 6, 7, 8, 9, 10, 11, 13, 14	Seal kit NBR	N-CEE40K6_X_	X731-040_X_D000N00
5, 6, 7, 8, 9, 10, 11, 13, 14	Seal kit FKM	V-CEE40K6_X_	X731-040_X_D000V00
15	Spring R	CEE40K6	XEF10536
15	Spring S	CEE40K6	XEF10537
15	Spring package T	CEE40K6	XEF10537 + XEF10538
15	Spring package U	CEE40K6	XEF10539 + XEF10538

Size 50

Position	Part designation	Description	Part number
	Disassembly tool	X731-050	XEB19149-050-00
5	O-ring - 70 Shore	Ø 78.74x5.33 mm	
7	O-ring - 70 Shore	Ø 69.44x3.53 mm	
9	O-ring - 70 Shore	Ø 59.92x3.53 mm	
11	O-ring - 90 Shore	Ø 64.00x3.00 mm	
5, 6, 7, 8, 9, 10, 11, 12	Seal kit NBR	N-CEE50K6_O_	X731-050_O_D000N00
5, 6, 7, 8, 9, 10, 11, 12	Seal kit FKM	V-CEE50K6_O_	X731-050_O_D000V00
5, 6, 7, 8, 9, 10, 11, 12, 13, 14	Seal kit NBR	N-CEE50K6_X_	X731-050_X_D000N00
5, 6, 7, 8, 9, 10, 11, 12, 13, 14	Seal kit FKM	V-CEE50K6_X_	X731-050_X_D000V00
15	Spring R	CEE50K6	XEF10508
15	Spring S	CEE50K6	XEF10509
15	Spring T	CEE50K6	XEF10510
15	Spring package U	CEE50K6	XEF10510 + XEF10511

ACCESSORIES AND SPARE PARTS

Size 63

Position	Part designation	Description	Part number
	Disassembly tool	X731-063	XEB19149-063-00
5	O-ring - 70 Shore	Ø 107.32x5.33 mm	
7	O-ring - 70 Shore	Ø 91.44x5.33 mm	
9	O-ring - 70 Shore	Ø 78.74x5.33 mm	
11	O-ring - 90 Shore	Ø 85.32x3.53 mm	
5, 6, 7, 8, 9, 10, 11, 12	Seal kit NBR	N-CEE63K6_O_	X731-063_O_D000N00
5, 6, 7, 8, 9, 10, 11, 12	Seal kit FKM	V-CEE63K6_O_	X731-063_O_D000V00
5, 6, 7, 8, 9, 10, 11, 12, 13, 14	Seal kit NBR	N-CEE63K6_X_	X731-063_X_D000N00
5, 6, 7, 8, 9, 10, 11, 12, 13, 14	Seal kit FKM	V-CEE63K6_X_	X731-063_X_D000V00
15	Spring R	CEE63K6	XE10519
15	Spring S	CEE63K6	XE10520
15	Spring T	CEE63K6	XE10521
15	Spring package U	CEE63K6	XE10521 + XE10522

Size 80

Position	Part designation	Description	Part number
	Disassembly tool	X731-080	XEB19149-080-00
5	O-ring - 70 Shore	Ø 129.54x7.00 mm	
7	O-ring - 70 Shore	Ø 107.32x5.33 mm	
9	O-ring - 70 Shore	Ø 97.79x5.33 mm	
11	O-ring - 90 Shore	Ø 97.79x5.33 mm	
5, 6, 7, 8, 9, 10, 11, 12	Seal kit NBR	N-CEE80K6_O_	X731-080_O_D000N00
5, 6, 7, 8, 9, 10, 11, 12	Seal kit FKM	V-CEE80K6_O_	X731-080_O_D000V00
5, 6, 7, 8, 9, 10, 11, 12, 13, 14	Seal kit NBR	N-CEE80K6_X_	X731-080_X_D000N00
5, 6, 7, 8, 9, 10, 11, 12, 13, 14	Seal kit FKM	V-CEE80K6_X_	X731-080_X_D000V00
15	Spring R	CEE80K6	XE10532
15	Spring S	CEE80K6	XE10533
15	Spring T	CEE80K6	XE10534
15	Spring package U	CEE80K6	XE10534 + XE10535

ACCESSORIES AND SPARE PARTS

Size 100

Position	Part designation	Description	Part number
	Disassembly tool	X731-100	XEB19149-100-00
5	O-ring - 70 Shore	Ø 164.47x7.00 mm	
7	O-ring - 70 Shore	Ø 145.42x7.00 mm	
9	O-ring - 70 Shore	Ø 120.02x7.00 mm	
11	O-ring - 90 Shore	Ø 129.54x7.00 mm	
5, 6, 7, 8, 9, 10, 11, 12	Seal kit NBR	N-CEE100K6_O_	X731-100_O_D000N00
5, 6, 7, 8, 9, 10, 11, 12	Seal kit FKM	V-CEE100K6_O_	X731-100_O_D000V00
5, 6, 7, 8, 9, 10, 11, 12, 13, 14	Seal kit NBR	N-CEE100K6_X_	X731-100_X_D000N00
5, 6, 7, 8, 9, 10, 11, 12, 13, 14	Seal kit FKM	V-CEE100K6_X_	X731-100_X_D000V00
15	Spring R	CEE100K6	XE10523
15	Spring S	CEE100K6	XE10524
15	Spring T	CEE100K6	XE10525
15	Spring package U	CEE100K6	XE10525 + XE10526

ACCESSORIES AND SPARE PARTS

Plugs and Orifices for Poppet Installation

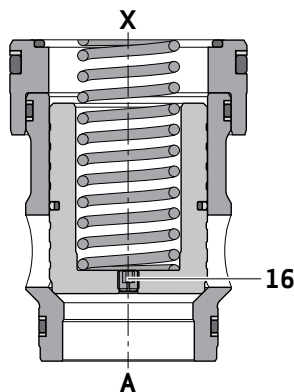

Notes:

- Tightening torques: M6 = 3.5 + 0.5 Nm (31 lbf in + 4 lbf in),
M8 = 10 + 0.8 Nm (89 lbf in + 7 lbf in)
- Secure orifices sufficiently (e.g. by using adhesive)

Size 16 to 40

Position	Part designation	Part number
16	Plug M6x6	CA37690-000
16	Orifice M6x6x0.6 mm	CA37690-060
16	Orifice M6x6x0.8 mm	CA37690-080
16	Orifice M6x6x1.0 mm	CA37690-100
16	Orifice M6x6x1.2 mm	CA37690-120
16	Orifice M6x6x1.5 mm	CA37690-150
16	Orifice M6x6x1.8 mm	CA37690-180

Size 50 to 100

Position	Part designation	Part number
16	Plug M8x8	X784-90800
16	Orifice M8x8x0.6 mm	X784-90806
16	Orifice M8x8x0.8 mm	X784-90808
16	Orifice M8x8x0.9 mm	X784-90809
16	Orifice M8x8x1.0 mm	X784-90810
16	Orifice M8x8x1.1 mm	X784-90811
16	Orifice M8x8x1.2 mm	X784-90812
16	Orifice M8x8x1.5 mm	X784-90815
16	Orifice M8x8x1.8 mm	X784-90818
16	Orifice M8x8x2.0 mm	X784-90820
16	Orifice M8x8x2.5 mm	X784-90825
16	Orifice M8x8x2.6 mm	X784-90826
16	Orifice M8x8x3.0 mm	X784-90830
16	Orifice M8x8x3.5 mm	X784-90835

REMOVAL TOOLS

Cartridge Sizes 16 to 50

The removal tools for the smaller valves consist of an expander and a striking weight.

Step A)

Remove the spring and poppet by hand.

Step B)

Insert the removal tool into the valve.

Use the grip (1) to expand the tool making sure that the pins (3) on the expander engage with the groove on the inside of the sleeve cap.

Use the striking weight (2) to remove the sleeve cap from the manifold.

Step C)

Using the same procedure, remove the valve sleeve from the manifold. Here it is important that the pins of the expander engage below the guide surface of the sleeve in the lateral holes. Otherwise damage may occur to the guide surface of the sleeve.

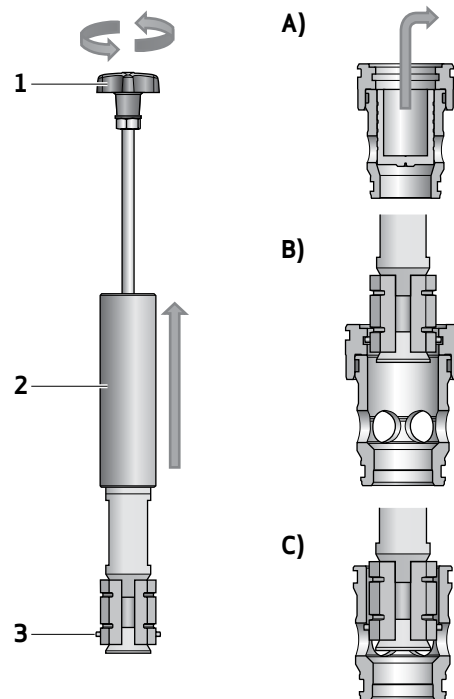

Cartridge Sizes 63 to 100

The removal tool for the larger valves consists of a bridge and a spindle.

Insert both threaded bolts of the bridge into the threaded holes of the manifold. Attach the bridge to the threaded bolts and lock into place. Screw the spindle into the sleeve cap then gently remove the sleeve cap by withdrawing the spindle. Repeat the same procedure to remove the valve sleeve from the manifold.

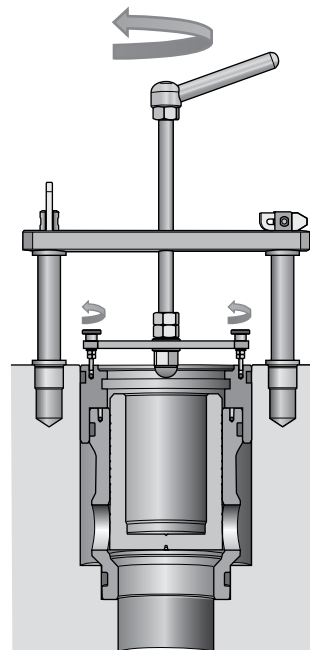

ABOUT MOOG

Moog Inc. is a worldwide designer, manufacturer and integrator of precision control components and systems. Moog's Industrial Group designs and manufactures high performance motion control solutions combining electric, hydraulic, and hybrid technologies with expert consultative support in a range of applications including energy production and generation machinery, industrial production machinery and simulation and test equipment. We help performance-driven companies design and develop their next-generation machines. Moog Industrial Group, with fiscal year 2012 sales of USD 634 million and locations in 26 countries, is part of Moog Inc. (NYSE:MOG.A and MOG.B) which has sales of USD 2.47 billion.

This vast scope ensures that our engineers remain close to the needs of machine builders and provide flexible design solutions and technical expertise tailored to our customers' toughest challenges.

Moog experts work in close collaboration with machine builders and application engineers to design motion control systems for greater productivity, higher reliability, superior connectivity, less costly maintenance and more effective operations. Our regional presence, industry knowledge and design flexibility ensures Moog motion control solutions are tailored to their environment — from meeting operating regulations and performance standards, to taking machine performance to a higher level.

Products

At the heart of every Moog solution is an array of products engineered for precision, high performance and reliability. For more than six decades, Moog products have been specified for critical machine applications.

Some are developed specifically for unique operating environments. Others are standard equipment on machines across many industries. All are continuously improved to take advantage of the latest technology breakthroughs and advancements.

Moog products include:

- Servo Valves and Proportional Valves
- Servo Motors and Servo Drives
- Servo Controllers and Software
- Radial Piston Pumps
- Actuators
- Integrated Hydraulic Manifold Systems and Cartridge Valves
- Slip Rings
- Motion Bases



Servo Valves

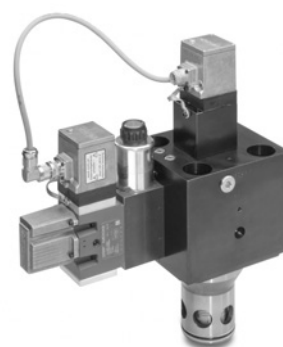

Servo Cartridge Valves

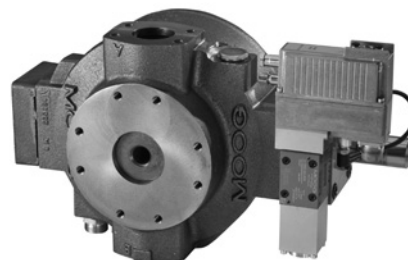

Radial Piston Pumps



Servo Drives

ABOUT MOOG

Solutions

Hydraulic solutions

Since Bill Moog invented the first commercially viable servo valve in 1951, Moog has set the standard for world-class hydraulic technology. Today, Moog products are used in a variety of applications - providing high power, enhanced productivity and ever better performance for some of the worlds most demanding applications.

Electric solutions

Clean operation, low noise generation, less maintenance and reduced power consumption make Moog electric solutions ideal for applications worldwide. Moog is the ideal partner for applications where transitioning technologies requires special expertise.

Hybrid solutions

By incorporating the advantages of existing hydraulic and electric technologies - including modular flexibility, increased efficiency and cleanliness - into innovative hybrid solutions, Moog offers new performance potential in specialized applications.

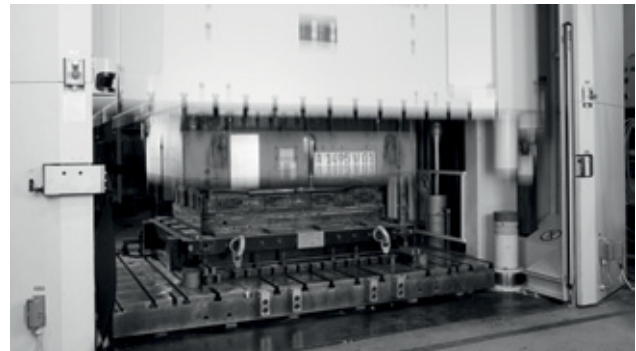

Press



Injection Molding Machine

Moog Global Support

Moog Global Support is our promise to offer world-class Repair and Maintenance Services delivered expertly by our trained technicians. With the reliability only available from a leading manufacturer with facilities around the world, Moog offers you service and expertise you can count on to keep your equipment operating as it should.

This promise offers many benefits to our customers including:

- Reduce your downtime by keeping critical machines running in peak performance
- Protect your investment by ensuring reliability, versatility and long-life of products
- Better plan your maintenance activities and make systematic upgrades
- Leverage our flexible programs to meet the unique service requirements of your facility

Look to Moog for global support including:

- Repair services using OEM parts are performed by trained technicians to the latest specifications
- Stock management of spare parts and products to prevent unplanned downtime

- Flexible programs, tailored to your needs such as upgrades, preventative maintenance and annual/multi-year contracts
- On-site services bring the expertise to you, providing quicker commissioning, set-up and diagnostics
- Access to reliable services that are guaranteed to offer consistent quality anywhere in the world

For more information on Moog Global Support visit www.moog.com/industrial/service.



ORDERING CODE

Type designation

	1	2	3	4	5	6	7	8	9	10	
N	-	C	E	E		K	6			/	

Seal materials	
N	NBR (standard)
V	FKM

Valve type	
C	Directional or pressure valve
R	Non-return valve

Valve function	
E	Slip-in cartridge valve without cover

Cover unit connection type	
E	Manifold installation

Nominal diameter [mm]	
16	ISO 7368-BA-06-2-A
25	ISO 7368-BB-08-2-A
32	ISO 7368-BC-09-2-A
40	ISO 7368-BD-10-2-A
50	ISO 7368-BE-11-2-A
63	ISO 7368-BF-12-2-A
80	ISO 7368-BG-13-2-A
100	ISO 7368-BH-14-2-A

Series	
K	Model range X731

Series	
6	Connecting dimensions according to ISO 7368

Orifice configuration	
KOB	Poppet without orifice bore
K99	Poppet with orifice bore, without nozzle ¹⁾
K09	Poppet with nozzle Ø 0.9 mm ¹⁾

¹⁾ Poppet B, C and F only available as KOB

Spring ²⁾	
Z	without spring
R	Spring R
S	Spring S
T	Spring T
U	Spring U
Q	Special spring

²⁾ Opening pressure, see table

Shaft seal	
O	Poppet without shaft seal
X	Poppet with shaft seal

Poppet type	
A	Pressure function area ratio 1:1
B	Directional function area ratio 1:1.5
C	Directional function 1:1.5 with damping
E	Pressure, directional function area ratio 1:1.07
F	Directional function 1:1.07 with damping

Spring opening pressures [bar]

A poppet, flow direction A → B									
Spring	16	25	32	40	50	63	80	100	
R	0.5	0.5	0.5	0.4	0.4	0.4	0.4	0.4	0.4
S	1.0	1.0	1.0	0.7	0.7	0.7	0.7	0.7	0.7
T	2.0	2.0	2.0	1.4	1.4	1.5	1.4	1.4	1.4
U	4.0	4.0	4.0	2.9	2.9	2.9	2.8	2.8	2.8

B and C poppet, flow direction A → B									
Spring	16	25	32	40	50	63	80	100	
R	0.5	0.5	0.5	0.5	0.5	0.5	0.5	0.5	0.5
S	1.0	1.0	1.0	1.0	1.0	1.0	1.0	1.0	1.0
T	1.9	2.1	2.0	2.0	2.0	2.0	2.0	2.0	2.0
U	3.8	4.2	4.0	4.0	4.0	4.0	4.0	4.0	4.0

E and F poppet, flow direction A → B									
Spring	16	25	32	40	50	63	80	100	
R	0.3	0.4	0.4	0.4	0.4	0.4	0.4	0.4	0.4
S	0.7	0.7	0.7	0.7	0.7	0.7	0.7	0.7	0.7
T	1.4	1.5	1.4	1.4	1.4	1.5	1.4	1.4	1.4
U	2.7	3.0	2.8	2.9	2.9	2.9	2.8	2.8	2.8

B and C poppet, flow direction B → A									
Spring	16	25	32	40	50	63	80	100	
R	0.9	1.0	1.0	1.0	1.0	1.0	1.0	1.0	1.0
S	1.9	2.1	2.0	2.0	2.0	2.0	2.0	2.0	2.0
T	3.8	4.2	4.0	4.0	4.0	4.0	4.0	4.0	4.0
U	7.6	8.3	7.9	8.1	8.0	8.1	8.0	8.0	8.0

E and F poppet, flow direction B → A									
Spring	16	25	32	40	50	63	80	100	
R	5.4	5.3	5.1	5.2	5.1	5.1	5.1	5.2	5.2
S	10.8	10.6	10.2	10.4	10.2	10.2	10.2	10.3	10.3
T	21.5	21.1	20.3	20.8	20.3	20.5	20.2	20.6	20.6
U	43.1	42.3	40.6	41.6	40.7	41.1	40.5	41.3	41.3

TAKE A CLOSER LOOK.

Moog designs a range of motion control products that complement the performance of those featured in this catalog. Visit our website for more information and contact the Moog facility nearest you.

Argentina
+54 11 4326 5916
info.argentina@moog.com

India
+91 80 4057 6666
info.india@moog.com

Singapore
+65 677 36238
info.singapore@moog.com

Australia
+61 3 9561 6044
info.australia@moog.com

Ireland
+353 21 451 9000
info.ireland@moog.com

South Africa
+27 12 653 6768
info.southafrica@moog.com

Brazil
+55 11 3572 0400
info.brazil@moog.com

Italy
+39 0332 421 111
info.italy@moog.com

Spain
+34 902 133 240
info.spain@moog.com

Canada
+1 716 652 2000
info.canada@moog.com

Japan
+81 46 355 3767
info.japan@moog.com

Sweden
+46 31 680 060
info.sweden@moog.com

China
+86 21 2893 1600
info.china@moog.com

Korea
+82 31 764 6711
info.korea@moog.com

Switzerland
+41 71 394 5010
info.switzerland@moog.com

Finland
+358 10 422 1840
info.finland@moog.com

Luxembourg
+352 40 46 401
info.luxembourg@moog.com

Turkey
+90 216 663 6020
info.turkey@moog.com

France
+33 1 4560 7000
info.france@moog.com

The Netherlands
+31 252 462 000
info.thenetherlands@moog.com

United Kingdom
+44 168 429 6600
info.uk@moog.com

Germany
+49 7031 622 0
info.germany@moog.com

Norway
+47 6494 1948
info.norway@moog.com

USA
+1 716 652 2000
info.usa@moog.com

Hong Kong
+852 2 635 3200
info.hongkong@moog.com

Russia
+7 831 713 1811
info.russia@moog.com

www.moog.com/industrial

Moog is a registered trademark of Moog Inc. and its subsidiaries. All trademarks as indicated herein are the property of Moog Inc. and its subsidiaries.

©2013 Moog Inc. All rights reserved. All changes are reserved.

2-way Slip-in Cartridge Valves - Directional and Pressure Function
PIM, Rev. A, June 2013, CDL34559-en