

# MAXFORCE

## PRE-ENGINEERED ELECTRIC LINEAR ACTUATION SOLUTION SIZE 4

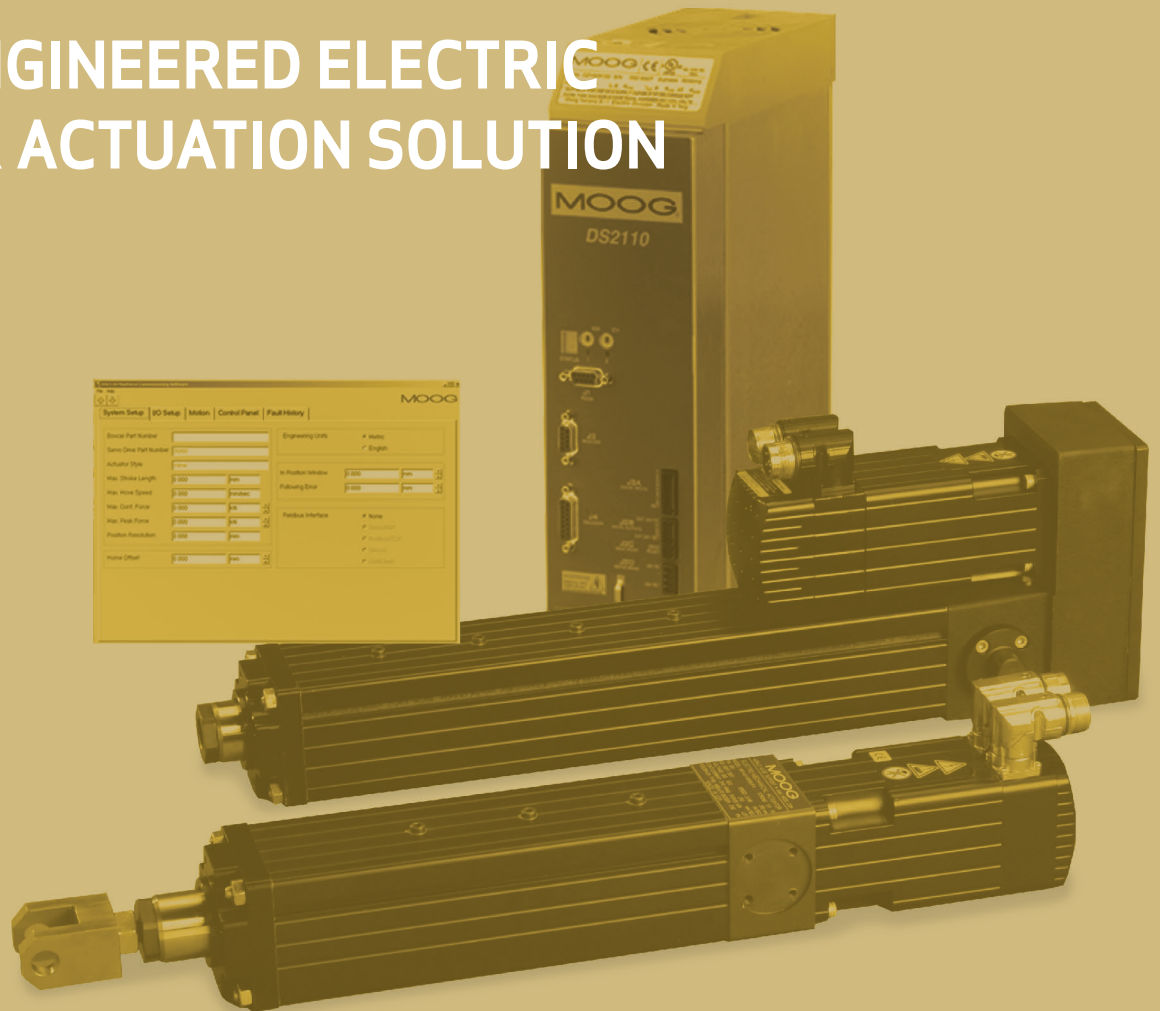

THE ELECTRO-MECHANICAL SOLUTION  
FOR HIGH PERFORMANCE ACTUATION

Moog MaxForce Pre-Engineered Electric Actuation Solutions provide an electro-mechanical alternative to traditional hydraulic actuation. Combining an electro-mechanical servoactuator, a servodrive and integrated software, this high performance solution delivers world-class motion control to a wide array of linear applications, ensuring high speed and high force in today's most demanding industrial environments.

INTRODUCTION	3
300 VOLT SERVOMOTOR PERFORMANCE SPECIFICATIONS	4
CURVES 1:1 GEAR RATIO	5
CURVES 1:1.4 GEAR RATIO	6
CURVES 1:1.67 GEAR RATIO	7
600 VOLT SERVOMOTOR PERFORMANCE SPECIFICATIONS	8
CURVES 1:1 GEAR RATIO	9
CURVES 1:1.4 GEAR RATIO	10
CURVES 1:1.67 GEAR RATIO	11
INLINE DIMENSIONS	12
FOLDBACK DIMENSIONS	12
ELECTRICAL SCHEMATIC	13
ROD END KITS	14
ORDERING INFORMATION	15
DS2110 TECHNICAL DATA	16



This catalog is for users with technical knowledge. To ensure that all necessary characteristics for function and safety of the system are given, the user has to check the suitability of the products described herein. The products described herein are subject to change without notice. In case of doubt, please contact Moog.

For the most current information, visit [www.moog.com/servomotorsanddrives](http://www.moog.com/servomotorsanddrives)

Moog is a registered trademark of Moog Inc. and its subsidiaries. All trademarks as indicated herein are the property of Moog Inc. and its subsidiaries.

©Moog Inc. 2007. All rights reserved. All changes are reserved.

## An Integrated System Designed To Achieve Maximum Machine Performance

### PERFORMANCE

- Long lasting performance and reliability with integrated design and reduced part count
- Pre-engineered system - servoactuator, servodrive, software - allows for easy set-up and installation

### PRECISION

- Ensures more accurate precision motion control
- Low inertia servomotors for higher acceleration
- Lower audible noise compared to hydraulic installation

### EFFICIENCY

- Reduces maintenance and operating costs
- Match unique machine designs with a full range of options, sizes and configurations
- Reduces energy consumption
- Eliminates oil leaks

### COMMISSIONING SOFTWARE

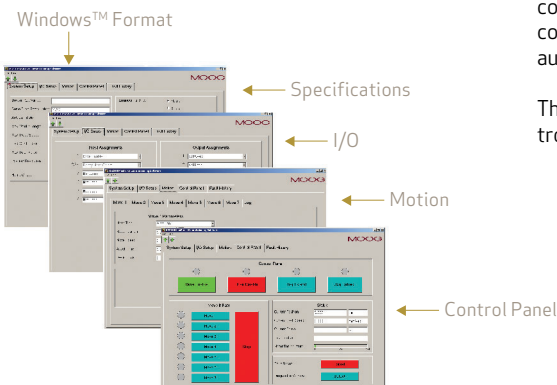

### Components optimized to work together

The MaxForce Pre-Engineered Electric Linear Actuation Solution is an actuation package that employs Moog's innovative brushless servomotor and ball-screw technology, a state-of-the-art servodrive and user-friendly commissioning software. All of the components are optimized to work together to provide the highest level of performance and accuracy.

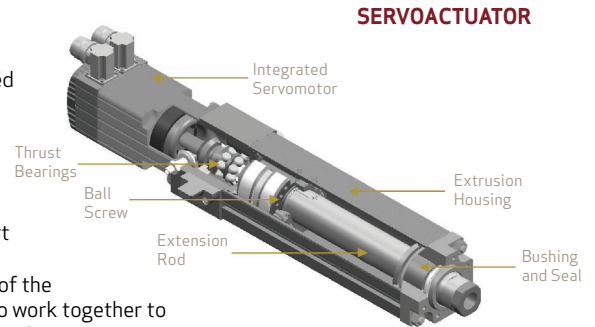

### Engineered in advance

Moog's depth of motion control expertise provides you with a flexible solution unique to your machine needs. Moog has engineered the majority of the work in advance so that with minimal effort the system can be easily implemented into your application.

### World-class components for high performance

The MaxForce Pre-Engineered Electric Linear Actuation Solution features genuine Moog components so you can rest assured that you're getting the world-class performance today's design engineers have come to trust.

### User-friendly software

Moog's intuitive commissioning software helps the user reduce system setup time.

The commissioning software saves time at system start up by automatically uploading preset system tuning parameters from the absolute encoder. The software also ensures error-free start up by implementing preset safety limits for speed, force and stroke length.

The Servodrive is programmed in user-friendly engineering units eliminating the need for the conversion from RPM to rod speed, from servomotor current to force and from encoder counts to position. This information is preprogrammed into the servoactuator encoder for automatic upload.

There is also a Control Panel function and Fault History which allows ease of setup and troubleshooting. Various levels of intelligence and communication options are available.

### SERVOACTUATOR

### SERVO DRIVE



### SERVOMOTOR PERFORMANCE 300 VOLT

Servomotor Stack Number	Rotor Inertia	Brake Inertia	Continuous Stall Torque Nm (inf-lb)	Peak Stall Torque Nm (inf-lb)	Nominal Speed RPM	Brake Holding Torque Nm (inf-lb)	Continuous Current Arms	Peak Current Arms
	kg*cm <sup>2</sup> (lbf*in*s <sup>2</sup> )	kg*cm <sup>2</sup> (lbf*in*s <sup>2</sup> )						
-8	4.70 (0.00416)	1.00 (0.00089)	8.20 (72.6)	22.00 (194.7)	3500.0	18.00 (159.3)	9.2	28
-9	6.80 (0.00602)	1.00 (0.00089)	12.50 (110.60)	35.00 (309.8)	2800.0	18.00 (159.3)	9.6	30

### SERVOACTUATOR PERFORMANCE

Nominal Backlash	mm (in)	0.002 (0.0000787)
Maximum Backlash	mm (in)	0.02 (0.000787)
Lead Accuracy	mm/300mm (in/ft)	0.023 (0.000906)
Resolution	mm (in)	0.00001 (0.00000039)
Maximum Static Load	kN (lb)	41 (9217.63)
Screw Diameter	mm (in)	32 (1.25)
Environmental Rating		IP65
Stroke range	mm (in)	75-2000 (3.9-59)
Standard Strokes	mm (in)	100, 200, 300, 400, 500, 750, 1000, 1500, 2000 (3.9, 7.8, 11.8, 15.7, 19.6, 29.5, 39.3, 59, 78.7)
Servoactuator Mass adder/unit stroke	kg/mm (lb/in)	0.0191 (1.070)

Servomotor Stack Number	Servo-actuator Form	Servo-actuator Base Mass kg (lb)	Gear Ratio 1:	Screw Lead mm	Cont. Stall Force	Peak Stall Force	Brake Holding Force	Max. Speed	Max. Linear Inertia	Dynamic Load Rating			
					kN (lbf)	kN (lbf)	kN (lbf)	mm/sec (in/sec)	kg (lb)	kN (lbf)			
-8	inline	24.6 (54.1)	1	5	8.64 (1943)	23.51 (5285)	19.96 (4486)	313 (12.3)	5610 (12364)	31.7 (7127)			
				10	4.32 (971)	11.75 (2642)	9.98 (2243)	625 (24.6)	1402 (3091)	33.2 (7464)			
				20	2.16 (486)	5.88 (1321)	4.99 (1122)	1250 (49.2)	351 (773)	31.1 (6992)			
				foldback	31.1 (68.5)	1	5	8.64 (1943)	23.51 (5285)	19.96 (4486)	313 (12.3)	4441 (9788)	31.7 (7127)
							10	4.32 (971)	11.75 (2642)	9.98 (2243)	625 (24.6)	1110 (2447)	33.2 (7464)
							20	2.16 (486)	5.88 (1321)	4.99 (1122)	1250 (49.2)	278 (612)	31.1 (6992)
	foldback	31.1 (68.5)	1.4	5	12.10 (2720)	24.90 (5598)	27.94 (6281)	262 (10.3)	11115 (24497)	31.7 (7127)			
				10	6.05 (1360)	16.45 (3699)	13.97 (3141)	524 (20.6)	2779 (6124)	33.2 (7464)			
				20	3.02 (680)	8.23 (1850)	6.98 (1570)	1048 (41.2)	695 (1531)	31.1 (6992)			
				1.67	5	14.43 (3244)	24.90 (5598)	33.33 (7492)	220 (8.6)	16936 (37328)	31.7 (7127)		
					10	7.21 (1622)	19.63 (4413)	16.66 (3746)	439 (17.3)	4234 (9332)	33.2 (7464)		
					20	3.61 (811)	9.81 (2206)	8.33 (1873)	878 (34.6)	1059 (2333)	31.1 (6992)		
-9	inline	27.7 (60.9)	1	5	13.38 (3008)	24.90 (5598)	19.96 (4486)	250 (9.8)	8919 (19659)	31.7 (7127)			
				10	6.69 (1504)	18.76 (4218)	9.98 (2243)	500 (19.7)	2230 (4915)	33.2 (7464)			
				20	3.34 (752)	9.38 (2109)	4.99 (1122)	1000 (39.4)	557 (1229)	31.1 (6992)			
				foldback	14.4 (31.7)	1	5	13.38 (3008)	24.90 (5598)	19.96 (4486)	250 (9.8)	7757 (17097)	31.7 (7127)
							10	6.69 (1504)	18.76 (4218)	9.98 (2243)	500 (19.7)	1939 (4274)	33.2 (7464)
							20	3.34 (752)	9.38 (2109)	4.99 (1122)	1000 (39.4)	485 (1069)	31.1 (6992)
	foldback	14.4 (31.7)	1.4	5	18.73 (4211)	24.90 (5598)	27.94 (6281)	179 (7.0)	17615 (38823)	31.7 (7127)			
				10	9.36 (2105)	22.43 (5043)	13.97 (3141)	357 (14.1)	4404 (9706)	33.2 (7464)			
				20	4.68 (1053)	11.22 (2521)	6.98 (1570)	714 (28.1)	1101 (2426)	31.1 (6992)			
				1.67	5	22.34 (5023)	24.90 (5598)	33.33 (7492)	150 (5.9)	26185 (57712)	31.7 (7127)		
					10	11.17 (2511)	20.51 (4612)	16.66 (3746)	299 (11.8)	6546 (14428)	33.2 (7464)		
					20	5.59 (1256)	10.26 (2306)	8.33 (1873)	599 (23.6)	1637 (3607)	31.1 (6992)		

### DEFINITIONS

**Continuous Stall Force:** Force produced by the servoactuator at the continuous servomotor torque and at zero speed. Continuous force declines as servomotor speed increases. Consult performance curves for force rating at higher speeds. Continuous servomotor torque is limited by temperature and thus, the continuous force will be reduced with ambient temperatures above 25°C.

**Peak Stall Force:** Force produced by the servoactuator at the peak servomotor torque and at zero speed. Peak force declines as servomotor speed increases. Consult performance curves for force rating at higher speeds. Peak force can be held only for short durations (typically less than 1 minute) after which a cool down period at less than the continuous rating is required.

**Brake Holding Force:** Maximum force that the optional brake will hold stationary. Brake should not be used to stop a moving servoactuator as damage to the brake will result.

**Maximum Static Load:** Mechanical load limit of the servoactuator components. This is a limitation of the structural components of the servoactuator.

**Dynamic Load Rating:** The load at which the estimated life of a ballscrew or bearing will be 1 million revolutions

**Maximum Speed:** The maximum linear speed for the servoactuator. The available force at maximum speed is significantly less than the Stall Forces. Consult the Performance curves for Force/Speed relationship.

**Accuracy:** The ability of a positioning system to move exactly to a commanded position.

**Repeatability:** The ability of a positioning system to return to the same point from the same direction with the same load.

**Resolution:** The smallest positioning increment possible.

**Lead Accuracy:** The maximum deviation from nominal lead over specified interval.

**Maximum Linear Inertia:** This is the maximum load mass that can be connected to the servoactuator. This mass results in 10:1 inertia match to servomotor with 1000 mm stroke. Increasing stroke length will reduce this value while reducing stroke will increase this value. For exact inertia matching, refer to MaxForce sizing software.

**Servoactuator Base Mass:** This is the mass of the servoactuator with 0" stroke. To get total servoactuator mass multiply stroke X servoactuator mass adder and add to servoactuator base mass.

## 1:1 GEAR RATIO 300 VOLT

### Servomotor Stack Number -8

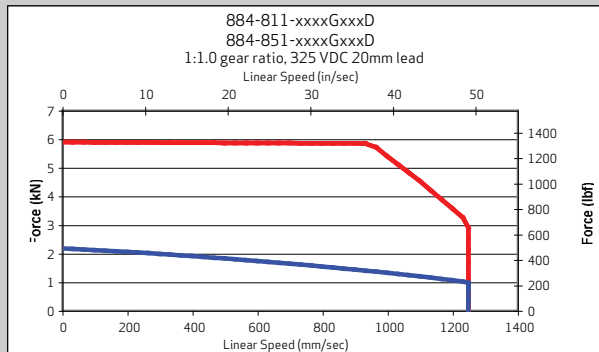
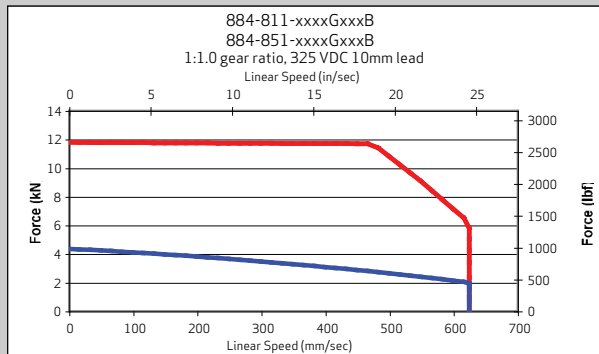
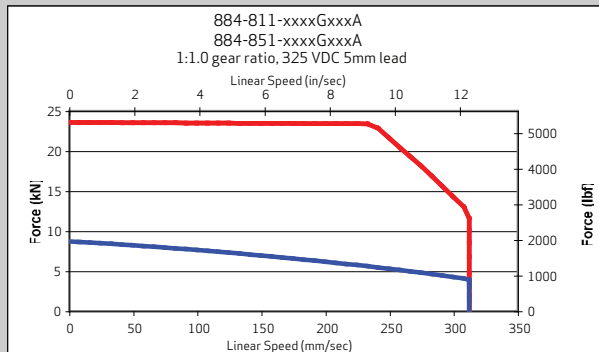

Continuous Force ————  
Peak Force ————

### Servomotor Stack Number -9

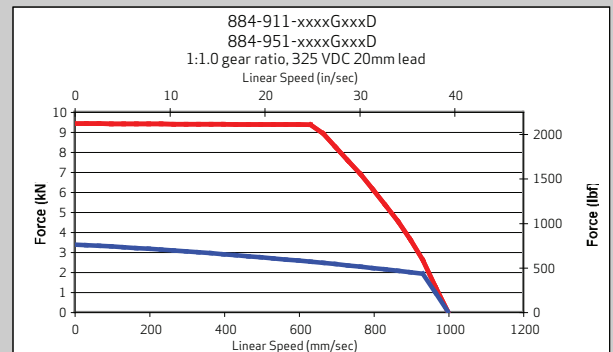
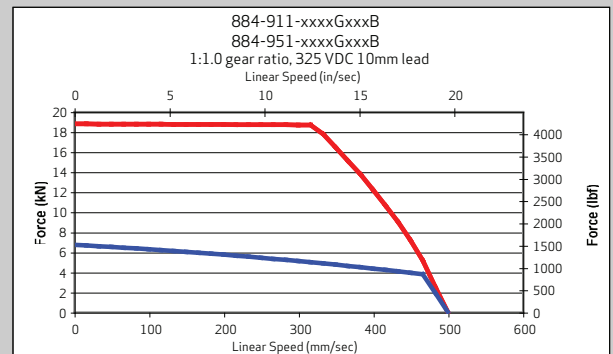
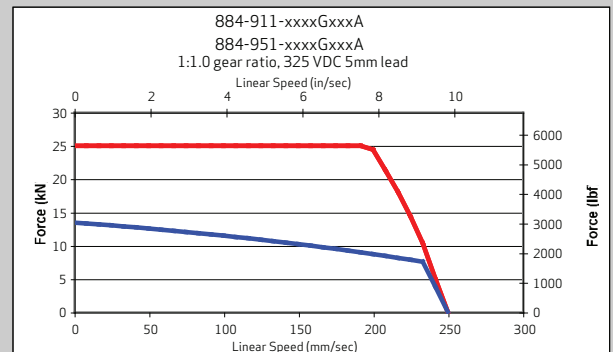

## 1:1.4 GEAR RATIO 300 VOLT

### Servomotor Stack Number -8

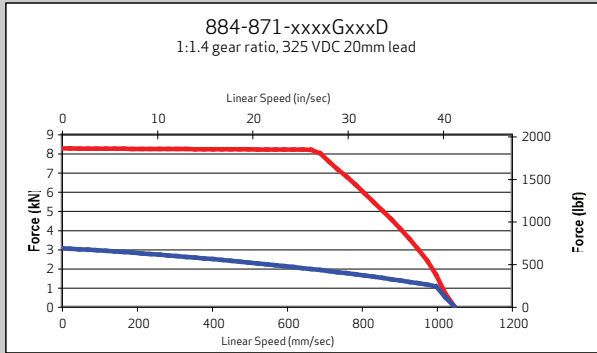
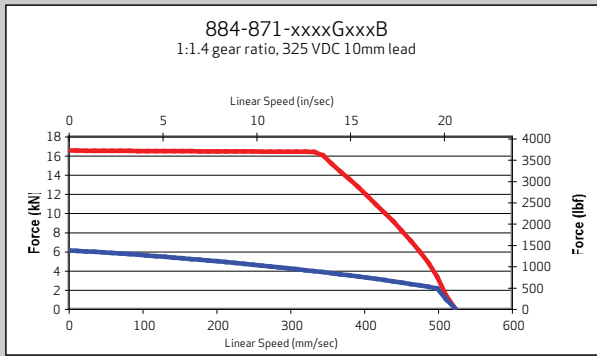
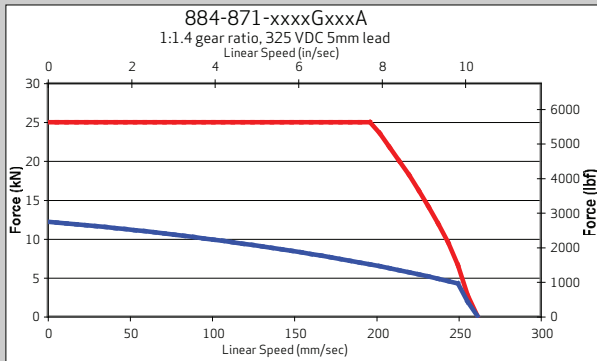

### Servomotor Stack Number -9

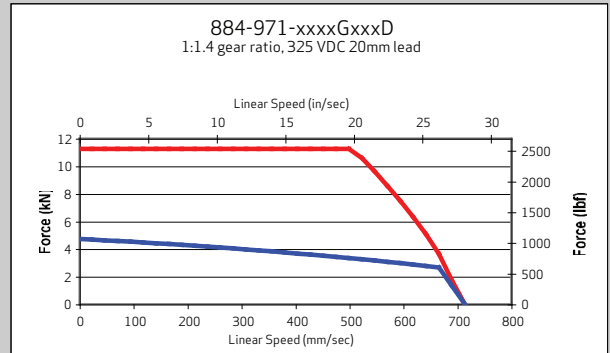
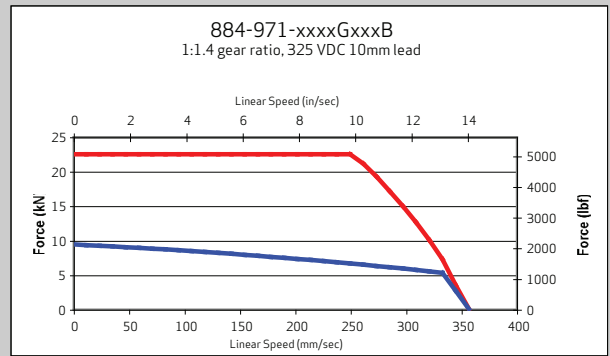
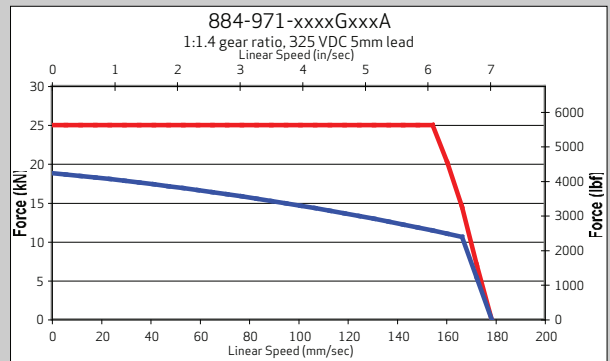

Continuous Force ———  
Peak Force ———

## 1:1.67 GEAR RATIO 300 VOLT

### Servomotor Stack Number -8

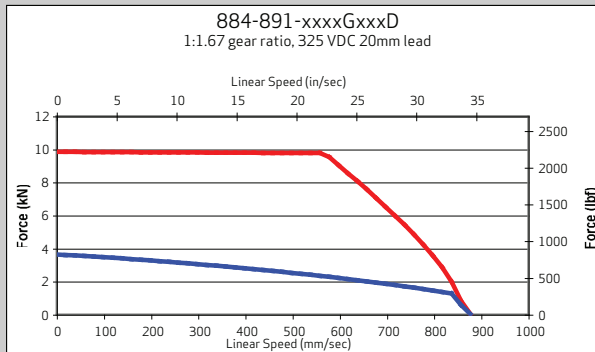
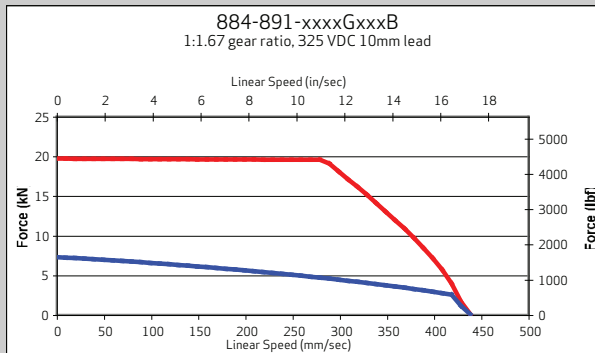
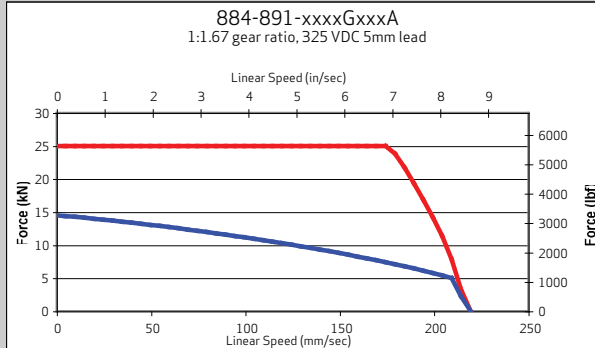

Continuous Force ————  
Peak Force ————

### Servomotor Stack Number -9

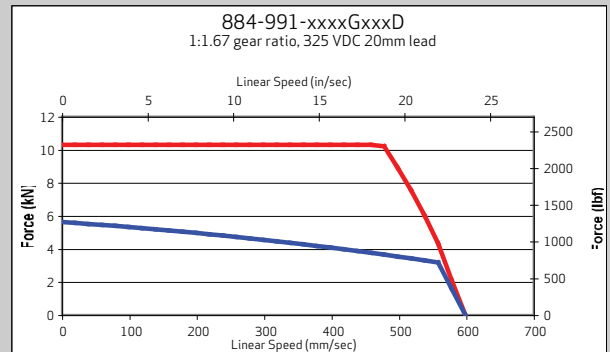
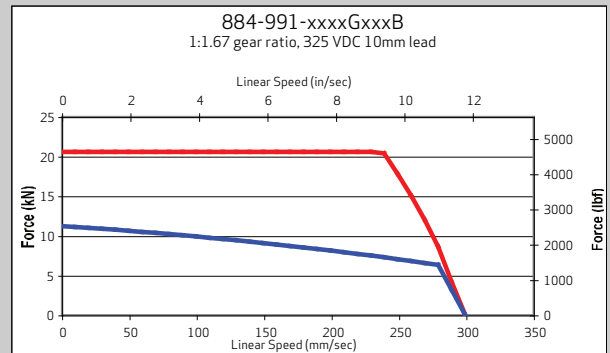
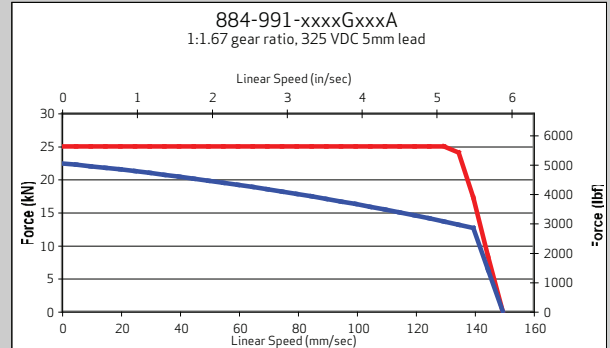

## SERVOMOTOR PERFORMANCE 600 VOLT

Servo-motor Stack Number	Rotor Inertia kg*cm <sup>2</sup> (lb*in*s <sup>2</sup> )	Brake Inertia kg*cm <sup>2</sup> (lb*in*s <sup>2</sup> )	Continuous Stall Torque Nm (in-lb)	Peak Stall Torque Nm (in-lb)	Nominal Speed RPM	Brake Holding Torque Nm (in-lb)	Continuous Current Arms	Peak Current Arms
-8	4.70 (0.00416)	1.00 (0.00089)	8.20 (72.6)	26.50 (234.6)	3300.0	18.00 (159.3)	5.8	18.5
-9	6.80 (0.00602)	1.00 (0.00089)	11.20 (99.1)	39.80 (352.3)	3000.0	18.00 (159.3)	5.6	20

## SERVOACTUATOR PERFORMANCE

Nominal Backlash	mm (in)	0.002 (0.0000787)
Maximum Backlash	mm (in)	0.02 (0.000787)
Lead Accuracy	mm/300mm (in/ft)	0.023 (0.000906)
Resolution	mm (in)	0.00001 (0.00000039)
Maximum Static Load	kN (lb)	41 (9217.63)
Screw Diameter	mm (in)	32 (1.25)
Environmental Rating		IP65
Stroke range	mm (in)	75-2000 (3.9-59)
Standard Strokes	mm (in)	100, 200, 300, 400, 500, 750, 1000, 1500, 2000 (3.9, 7.8, 11.8, 15.7, 19.6, 29.5, 39.3, 59, 78.7)
Servoactuator Mass adder/unit stroke	kg/mm (lb/in)	0.191 (1.070)

Servo-motor Stack Number	Servo-actuator Form	Servo-actuator Base Mass kg (lb)	Gear Ratio 1:	Screw Lead mm	Cont. Stall Force kN (lb)	Peak Stall Force kN (lb)	Brake Holding Force kN (lb)	Max. Speed mm/sec (in/sec)	Max. Linear Inertia kg (lb)	Dynamic Load Rating kN (lb)			
-8	inline	24.6 (54.1)	1	5	8.61 (1937)	21.71 (4881)	19.96 (4486)	313 (12.3)	5610 (12364)	31.7 (7127)			
				10	4.31 (968)	10.86 (2441)	9.98 (2243)	625 (24.6)	1402 (3091)	33.2 (7464)			
				20	2.15 (484)	5.43 (1220)	4.99 (1122)	1250 (49.2)	351 (773)	31.1 (6992)			
				foldback	31.1 (68.5)	1	5	8.61 (1937)	21.71 (4881)	19.96 (4486)	313 (12.3)	4441 (9788)	31.7 (7127)
							10	4.31 (968)	10.86 (2441)	9.98 (2243)	625 (24.6)	1110 (2447)	33.2 (7464)
							20	2.15 (484)	5.43 (1220)	4.99 (1122)	1250 (49.2)	278 (612)	31.1 (6992)
	1.4	5	12.06 (2711)	24.90 (5598)		27.94 (6281)	277 (10.9)	11115 (24497)	31.7 (7127)				
		10	6.03 (1356)	15.20 (3417)		13.97 (3141)	554 (21.8)	2779 (6124)	33.2 (7464)				
		20	3.01 (678)	7.60 (1708)		6.98 (1570)	1107 (43.6)	695 (1531)	31.1 (6992)				
	-9	inline	27.7 (60.9)	1	5	11.68 (2627)	24.90 (5598)	19.96 (4486)	283 (11.2)	8919 (19659)	31.7 (7127)		
					10	5.84 (1313)	12.26 (4780)	9.98 (2243)	567 (22.3)	2230 (4915)	33.2 (7464)		
					20	2.92 (657)	10.63 (2390)	4.99 (1122)	1133 (44.6)	557 (1229)	31.1 (6992)		
foldback					33.3 (73.4)	1	5	11.68 (2627)	24.90 (5598)	19.96 (4486)	283 (11.2)	7757 (17097)	31.7 (7127)
							10	5.84 (1313)	12.26 (4780)	9.98 (2243)	567 (22.3)	1939 (4274)	33.2 (7464)
							20	2.92 (657)	10.63 (2390)	4.99 (1122)	1133 (44.6)	485 (1069)	31.1 (6992)
1.4		5	16.36 (3678)	24.90 (5598)		27.94 (6281)	202 (8.0)	17615 (38823)	31.7 (7127)				
		10	8.18 (1839)	12.24 (5045)		13.97 (3141)	405 (15.9)	4404 (9706)	33.2 (7464)				
		20	4.09 (919)	11.22 (2523)		6.98 (1570)	810 (31.9)	1101 (2426)	31.1 (6992)				
1.67		5	19.51 (4387)	24.90 (5598)	33.33 (7492)	170 (6.7)	26185 (57712)	31.7 (7127)					
		10	9.76 (2193)	12.24 (5912)	16.66 (3746)	339 (13.4)	6546 (14428)	33.2 (7464)					
		20	4.88 (1097)	13.38 (3009)	8.33 (1873)	679 (26.7)	1637 (3607)	31.1 (6992)					

## DEFINITIONS

**Continuous Stall Force:** Force produced by the servoactuator at the continuous servomotor torque and at zero speed. Continuous force declines as servomotor speed increases. Consult performance curves for force rating at higher speeds. Continuous servomotor torque is limited by temperature and thus, the continuous force will be reduced with ambient temperatures above 25°C.

**Peak Stall Force:** Force produced by the servoactuator at the peak servomotor torque and at zero speed. Peak force declines as servomotor speed increases. Consult performance curves for force rating at higher speeds. Peak force can be held only for short durations (typically less than 1 minute) after which a cool down period at less than the continuous rating is required.

**Brake Holding Force:** Maximum force that the optional brake will hold stationary. Brake should not be used to stop a moving servoactuator as damage to the brake will result.

**Maximum Static Load:** Mechanical load limit of the servoactuator components. This is a limitation of the structural components of the servoactuator.

**Dynamic Load Rating:** The load at which the estimated life of a ballscrew or bearing will be 1 million revolutions

**Maximum Speed:** The maximum linear speed for the servoactuator. The available force at maximum speed is significantly less than the Stall Forces. Consult the Performance curves for Force/Speed relationship.

**Accuracy:** The ability of a positioning system to move exactly to a commanded position.

**Repeatability:** The ability of a positioning system to return to the same point from the same direction with the same load.

**Resolution:** The smallest positioning increment possible.

**Lead Accuracy:** The maximum deviation from nominal lead over specified interval.

**Maximum Linear Inertia:** This is the maximum load mass that can be connected to the servoactuator. This mass results in 10:1 inertia match to servomotor with 1000 mm stroke. Increasing stroke length will reduce this value while reducing stroke will increase this value. For exact inertia matching, refer to MaxForce sizing software.

**Servoactuator Base Mass:** This is the mass of the servoactuator with 0" stroke. To get total servoactuator mass multiply stroke X servoactuator mass adder and add to servoactuator base mass.



## 1:1 GEAR RATIO 600 VOLT

### Servomotor Stack Number -8

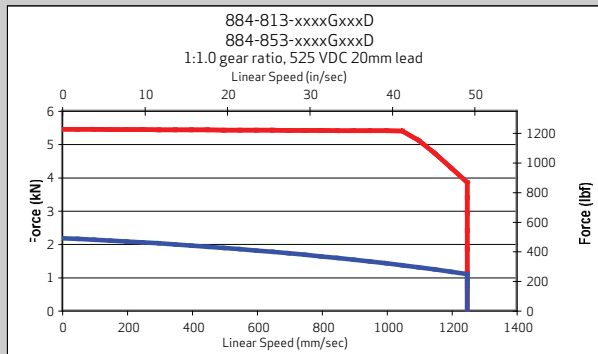
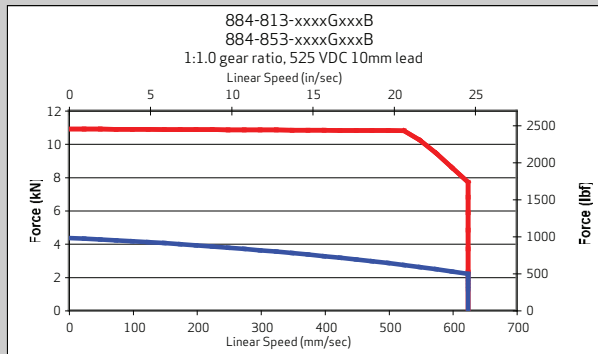
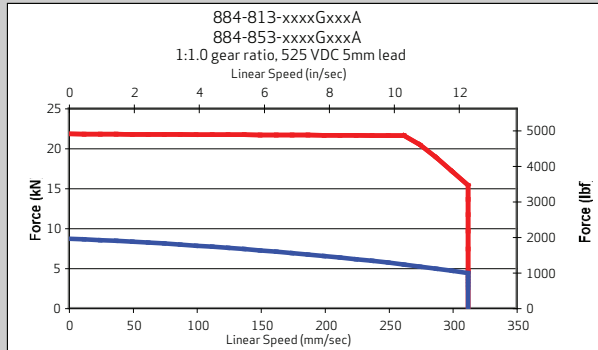

Continuous Force ————  
Peak Force ————

### Servomotor Stack Number -9

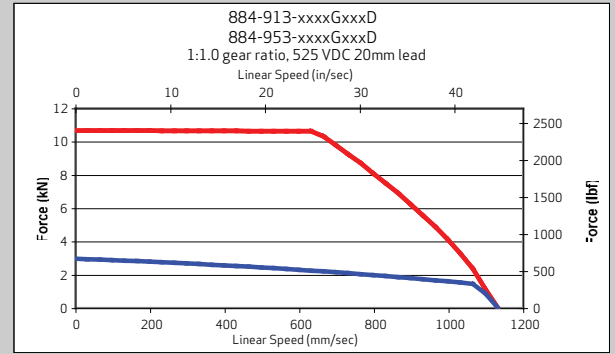
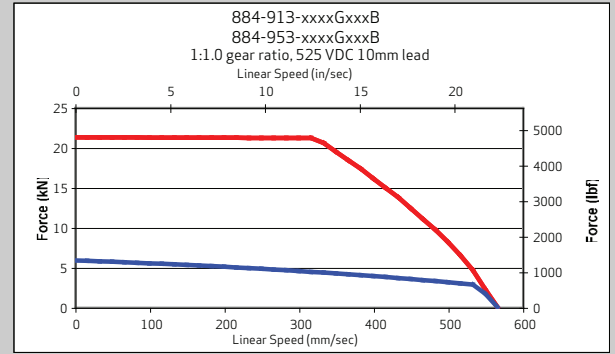
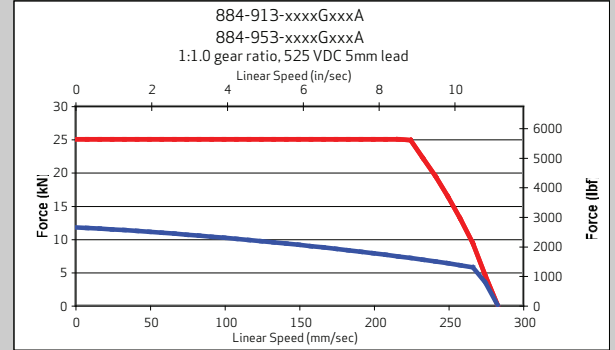

## 1:1.4 GEAR RATIO 600 VOLT

### Servomotor Stack Number -8

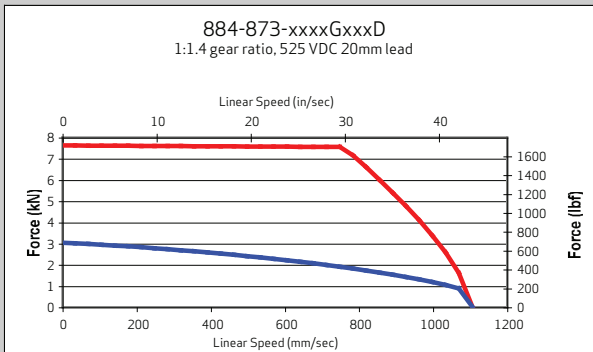
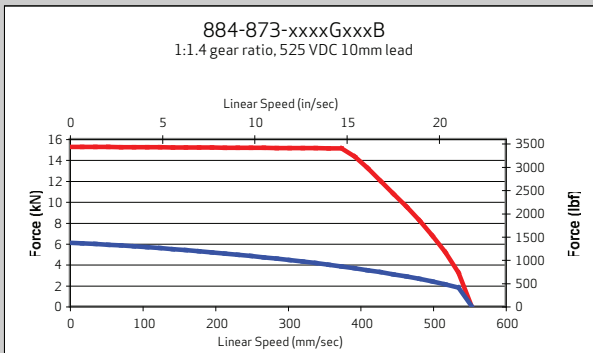
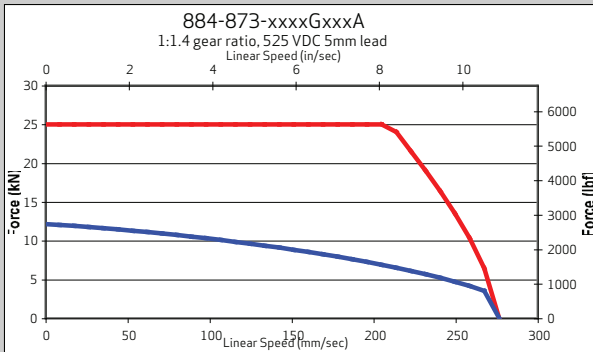

### Servomotor Stack Number -9

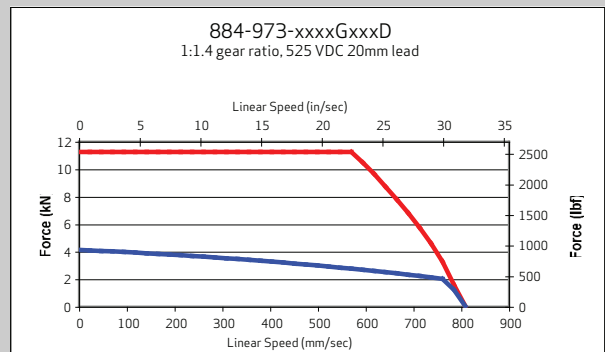
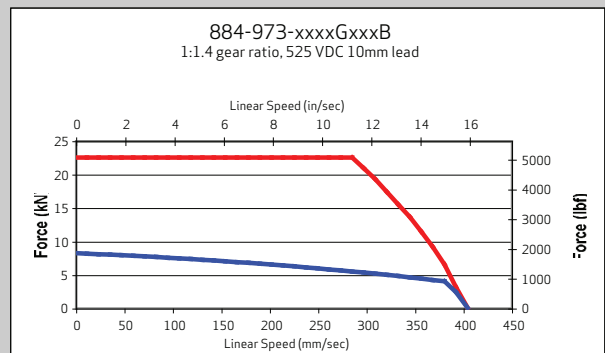
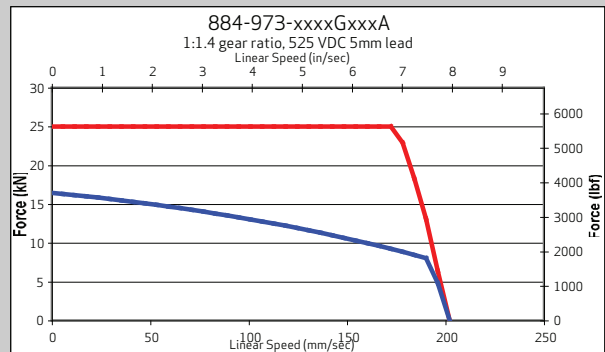

Continuous Force ———  
Peak Force ———

## 1:1.67 GEAR RATIO 600 VOLT

### Servomotor Stack Number -8

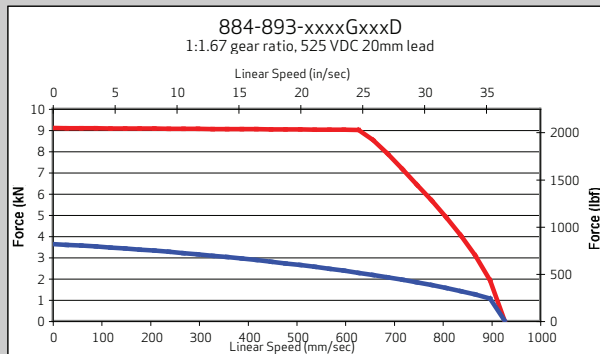
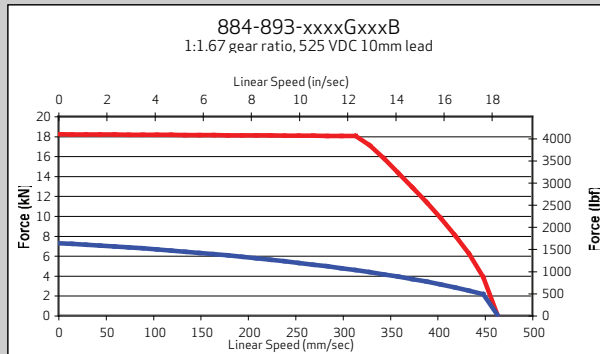
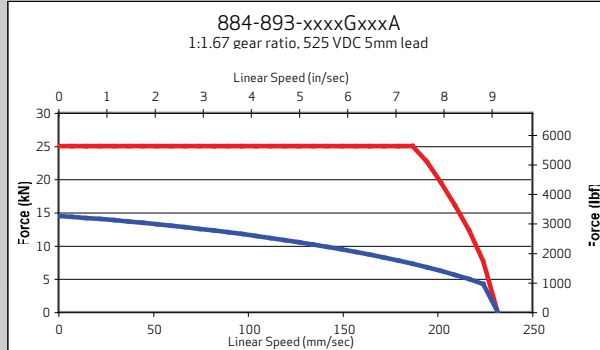

Continuous Force ———  
Peak Force ———

### Servomotor Stack Number -9

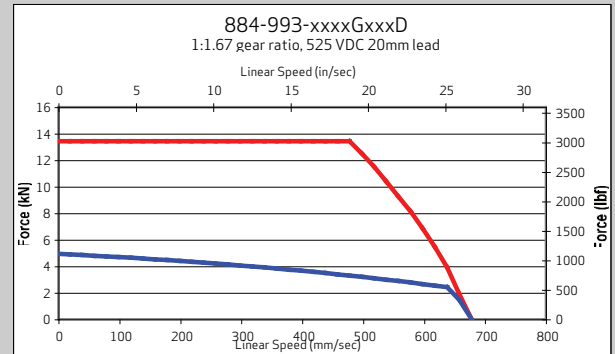
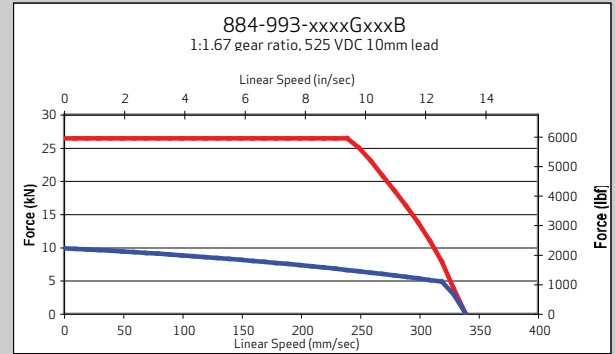
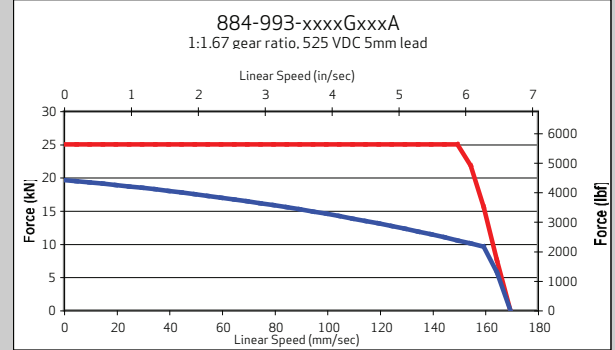

## INLINE SERVOACTUATOR

Servomotor Stack Number	X	Y
-8	100.5 (3.96)	273 (10.75)
-9	100.5 (3.96)	324 (12.76)

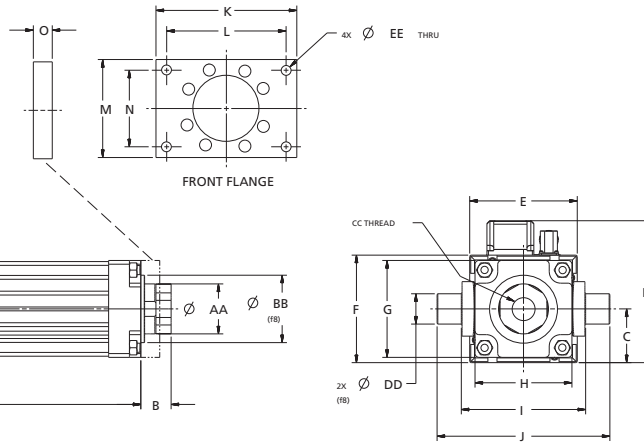

Dimensions mm (in)															
A	B	C	D	E	F	G	H	I	J	K	L	M	N	O	P
248	45	50.5	134	101	101	85	85	114	154	135	110	85	60	20	39
(9.76)	(1.77)	(1.99)	(5.28)	(3.98)	(3.98)	(3.35)	(3.35)	(4.49)	(6.06)	(5.31)	(4.33)	(3.35)	(2.36)	(0.79)	(1.54)
AA	BB	CC	DD	EE											
45	56	M27x2	25	11.5											
(1.77)	(2.20)	female	(0.98)	(0.45)											

## FOLDBACK SERVOACTUATOR

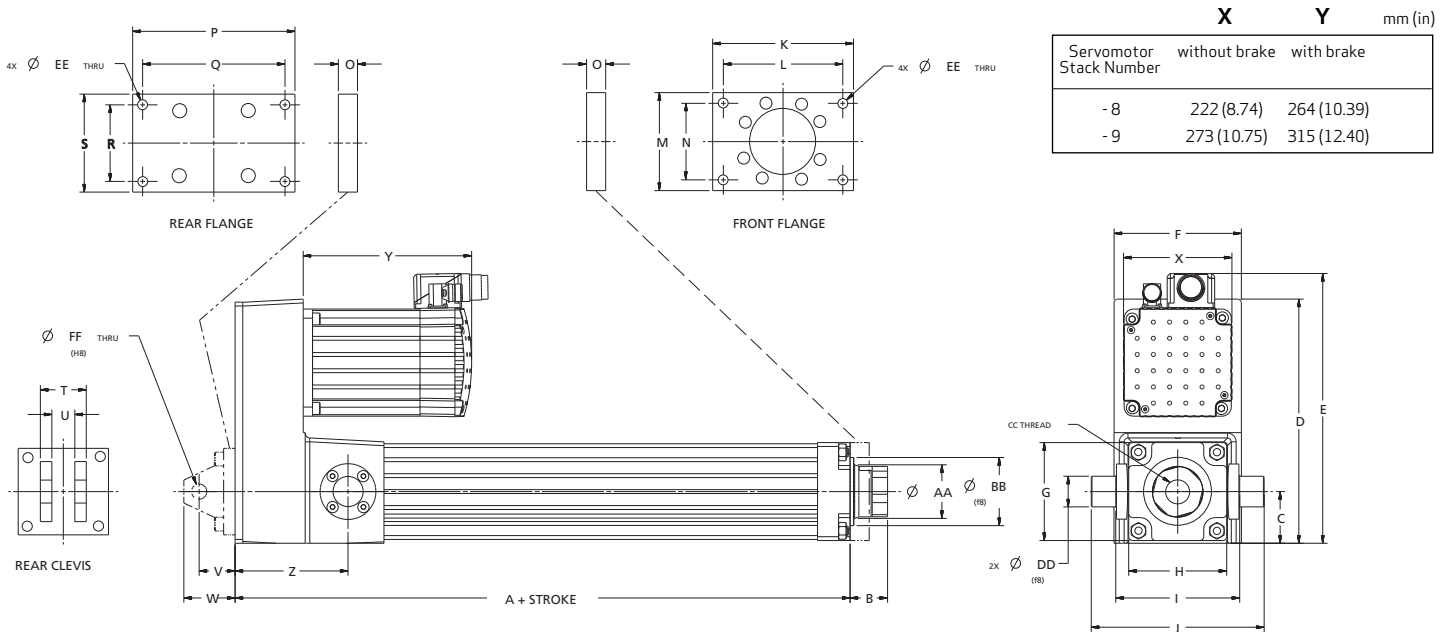

Servomotor Stack Number	mm (in)	
	X without brake	Y with brake
-8	222 (8.74)	264 (10.39)
-9	273 (10.75)	315 (12.40)

Dimensions mm (in)																
A	B	C	D	E	F	G	H	I	J	K	L	M	N	O	P	Q
343	45	50.5	219	241	112	85	85	114	154	135	110	85	60	20	160	138
(13.50)	(1.77)	(1.99)	(8.62)	(9.49)	(4.41)	(3.35)	(3.35)	(4.49)	(6.06)	(5.31)	(4.33)	(3.35)	(2.36)	(0.79)	(6.30)	(5.43)
R	S	T	U	V	W	Z	AA	BB	CC	DD	EE	FF				
60	85	60	30	44	64	127	45	56	M27x2	25	11.5	20				
(2.36)	(3.35)	(2.36)	(1.18)	(1.73)	(2.52)	(5.00)	(1.77)	(2.20)	female	(0.98)	(0.45)	(0.79)				

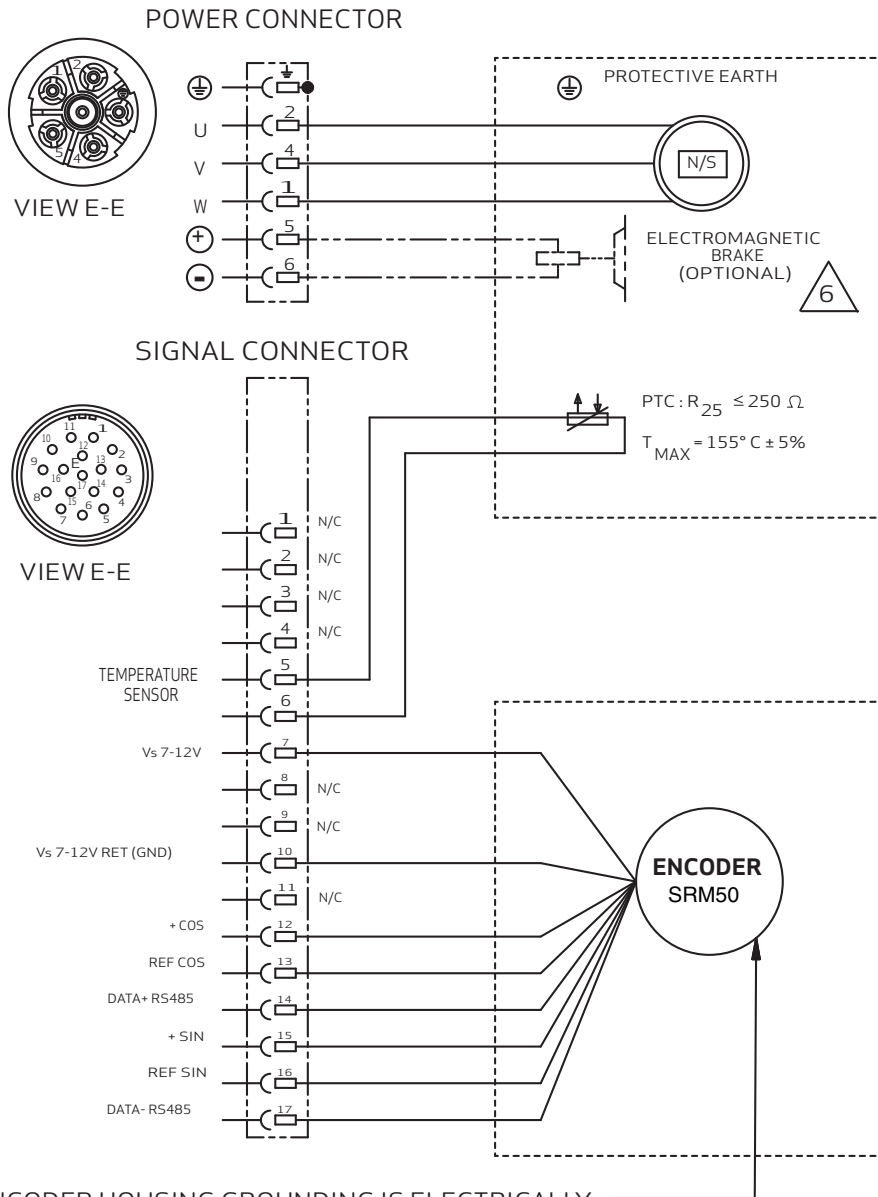

ENCODER HOUSING GROUNDING IS ELECTRICALLY CONNECTED TO THE MOTOR HOUSING VIA THE STATOR COUPLING. THE GND (0 V) CONNECTED TO SUPPLY VOLTAGE HAS NO CONNECTION TO THE ENCODER HOUSING.

## ELECTRICAL SCHEMATIC WITH ENCODER



(CODE: 1 OR 3)



CABLES (XXX = LENGTH IN METERS)  
 ENCODER: CA65132-001-XXX  
 POWER:  
 300V: C22294-001-XXX  
 600V: CA15987-001-XXX



ENERGIZE BRAKE TO RUN

**ROD END KITS**

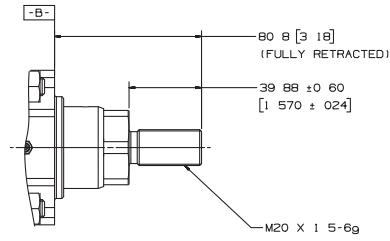

ROD END KIT, MALE END OPTION  
(CODE: 0)

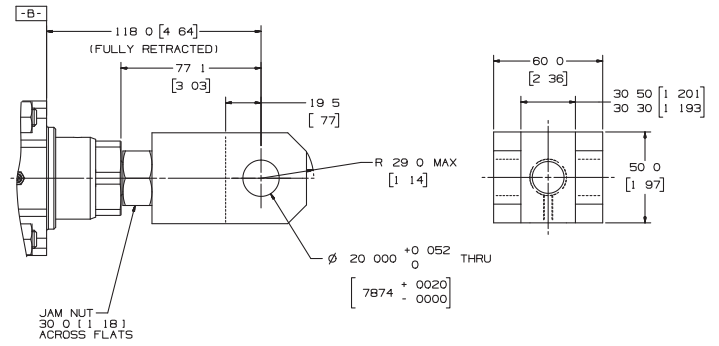

ROD END KIT, CLEVIS END OPTION  
(CODE: 3)

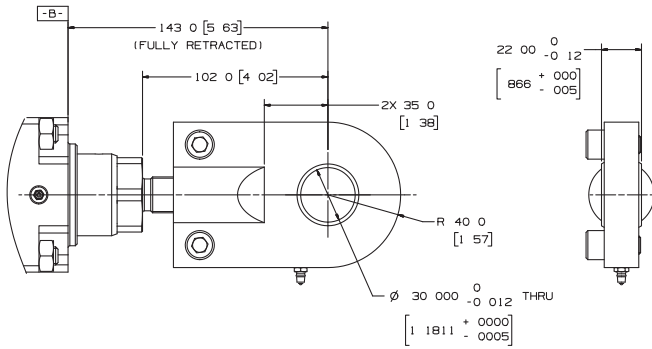

ROD END KIT, SPHERICAL BEARING OPTION  
(USED WITH INTERNAL ANTI-ROTATION)  
(CODE: 6)

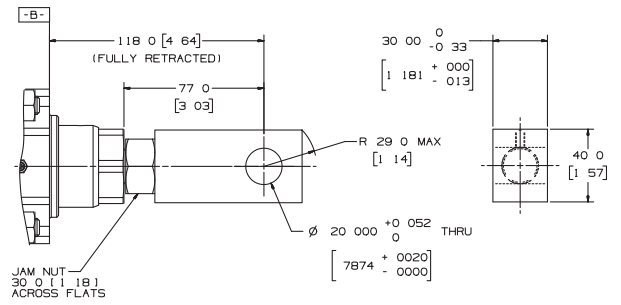

ROD EYE KIT, SPADE END OPTION  
(CODE: 4)

**BOXCAR MODEL NUMBER EXAMPLE**

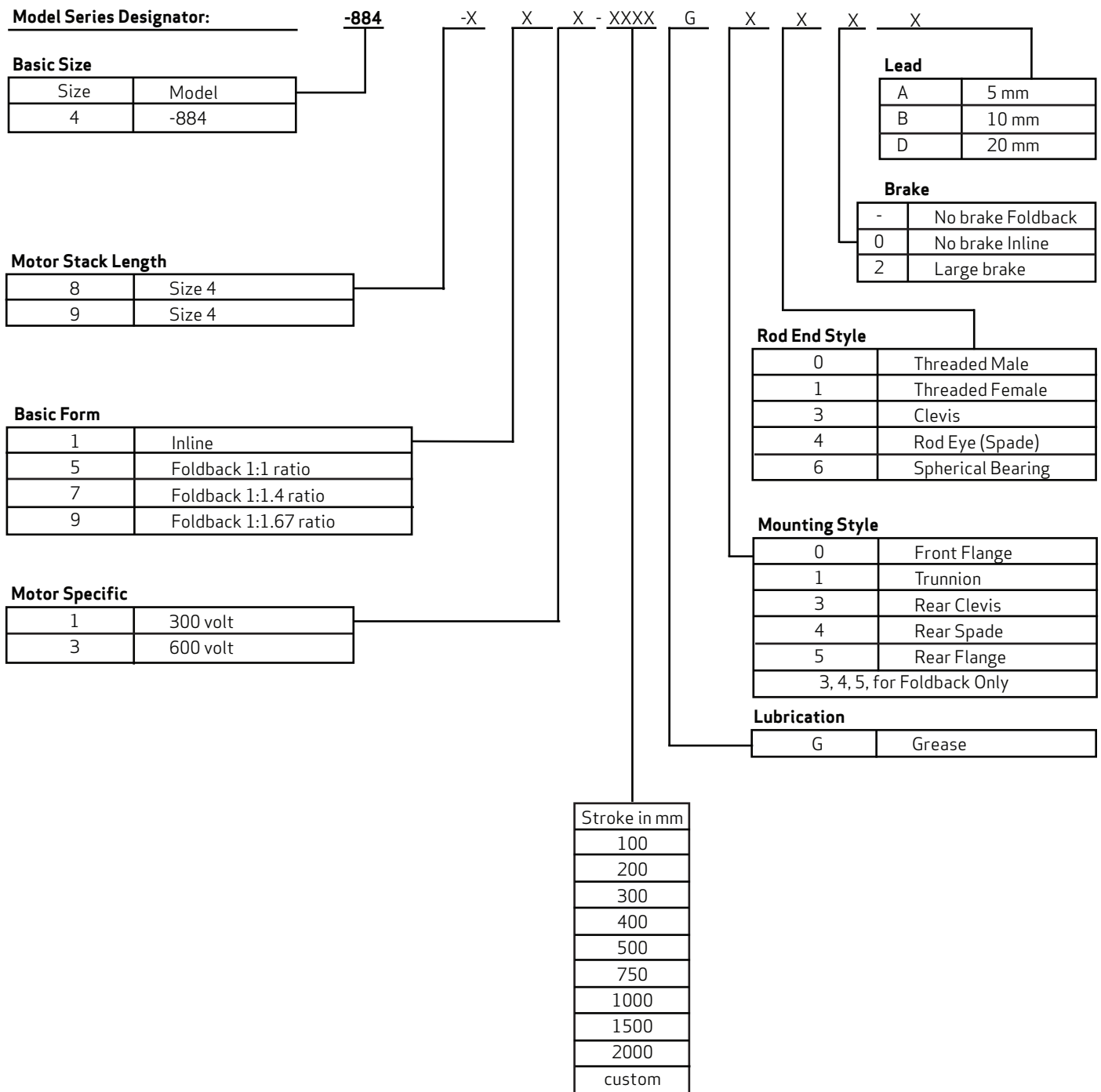

TECHNICAL DATA	
<b>Electrical Characteristics</b> Power supply Auxiliary power supply PWM Frequency Position control loop Frequency Speed control loop frequency Continuous / peak output current	3-phase, 65 Vac to 510 Vac, 1 phase, 103 to 243 VAC 24 Vdc, 2A 10 kHz 8 kHz 8 kHz 10A/42A with 3-phase supply
<b>Certifications include</b>	UL, CE, ODVA
<b>Environmental data</b> Operating ambient temperature Storage Temperature Thermal Protection Ingress Protection	0 to 40°C -25 to +55°C 70°C to de-rating the servodrive IP20
<b>Protection</b>	Servomotor and servodrive over temperature Out of tolerance power supply detection Encoder/Resolver missing signal detection Output Open/Short circuit detection I <sup>2</sup> T limiting Thermal foldback

### FIELDBUS

High-speed interfaces provide a fully digital link for receiving motion commands, providing feedback of status and initializing controller parameters.

#### Supported Fieldbuses include:

DeviceNet, Ethernet IP, and 16 bit Analog with Encoder Repeat.

#### Servomotor Feedback Supported:

Stegmann Absolute Encoders, Encoder Simulated Output

### Digital I/O

- Hardware enable input for process control
- Servomotor Brake Control Output
- Servodrive Ready Output
- Additional 7 programmable inputs and 3 programmable outputs allowing for custom servodrive functionality and monitoring

### SIZE 4 MAXFORCE SERVODRIVE ORDERING CODES

FieldBus Ordering Codes	
No Fieldbus	G362-010-00-A-902A
DeviceNet	G362-010-40-A-902A
Ethernet IP	G362-010-90-A-902A
16 Bit analog with encoder +/- 10v, 0-20mA	G362-010-70-A-902A



## CONNECTIONS SIZE B

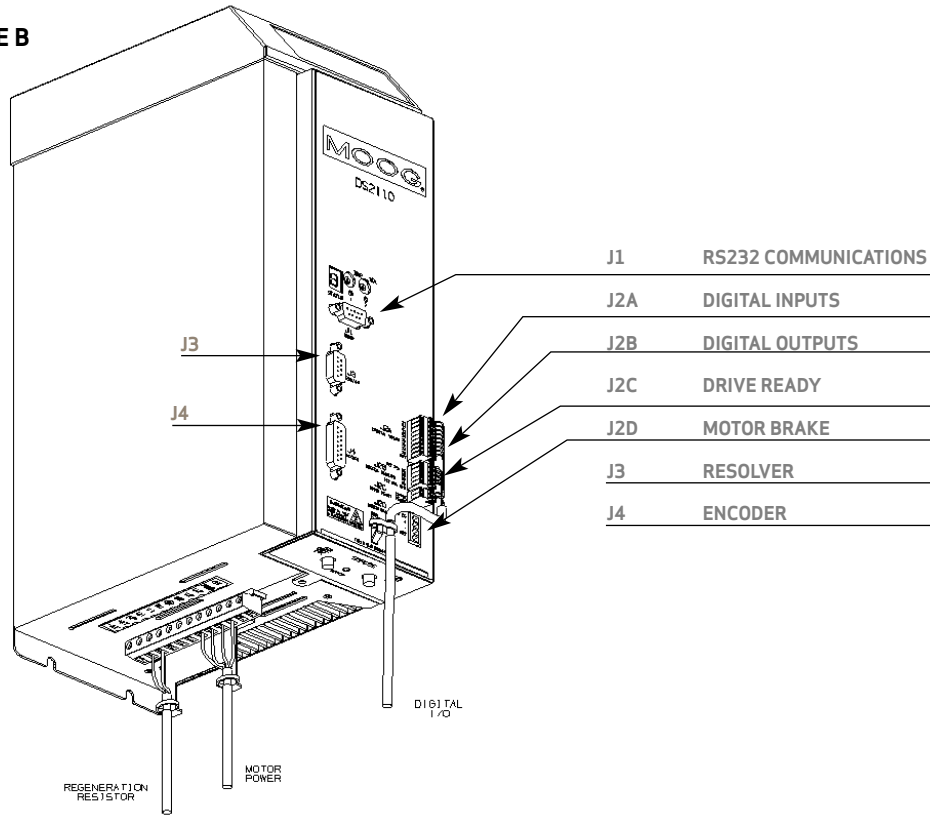

## DIMENSIONS

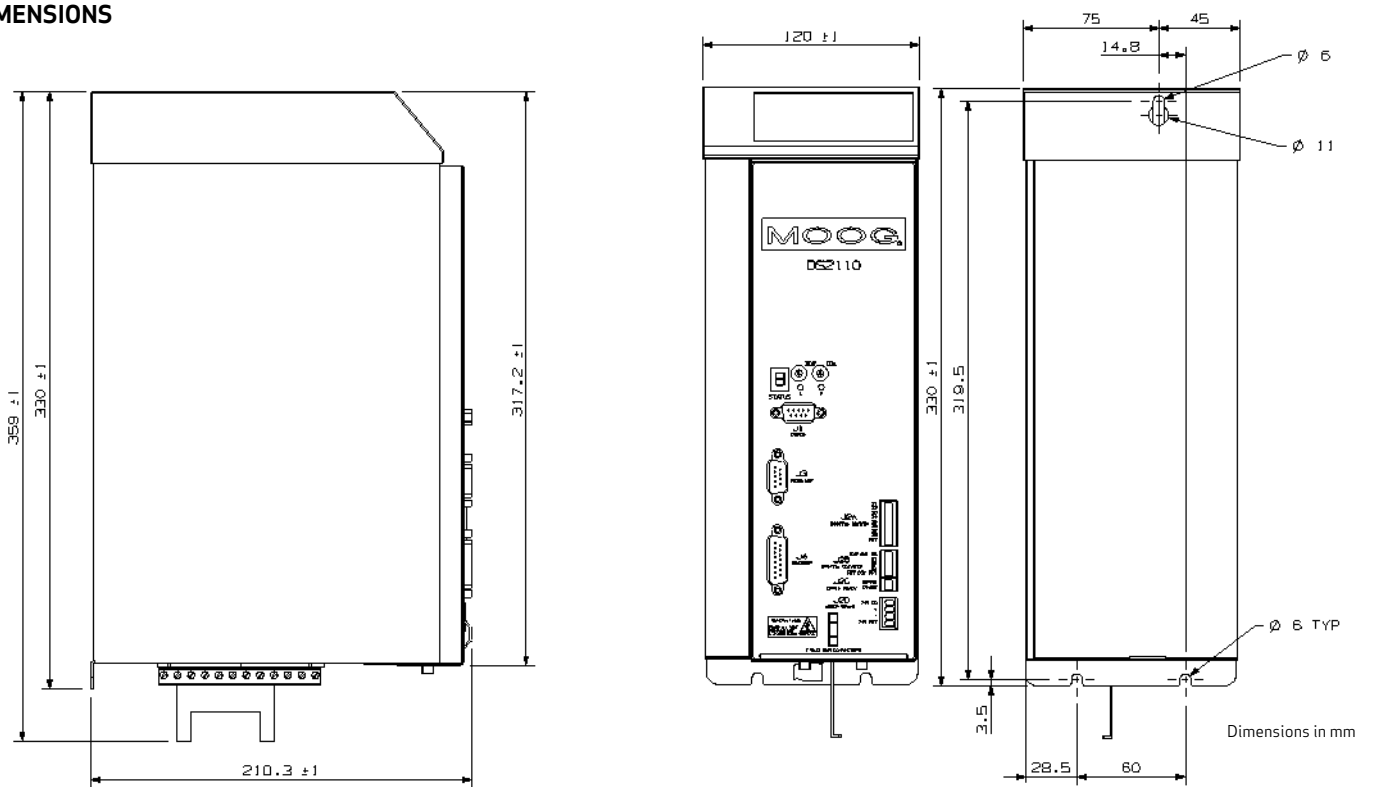

# TAKE A CLOSER LOOK

Solutions for MaxForce pre-engineered electro-mechanical actuation for high performance applications are readily available by calling +1 716 652 2000 or emailing us at [info.usa@moog.com](mailto:info.usa@moog.com)

For more information, visit our Web site or locate the distributor nearest you at [www.moog.com/industrial/distributorlocator](http://www.moog.com/industrial/distributorlocator).

[www.moog.com/industrial](http://www.moog.com/industrial)

©2007 Moog, Inc.

All trademarks as indicated herein are the property of Moog, Inc. and its subsidiaries. All rights reserved.

MaxForcePE Size4 CDL7230 1107  
TJW/PDF