

proceq

PROFOMETER® PM-6 ADVANCED COVER METERS

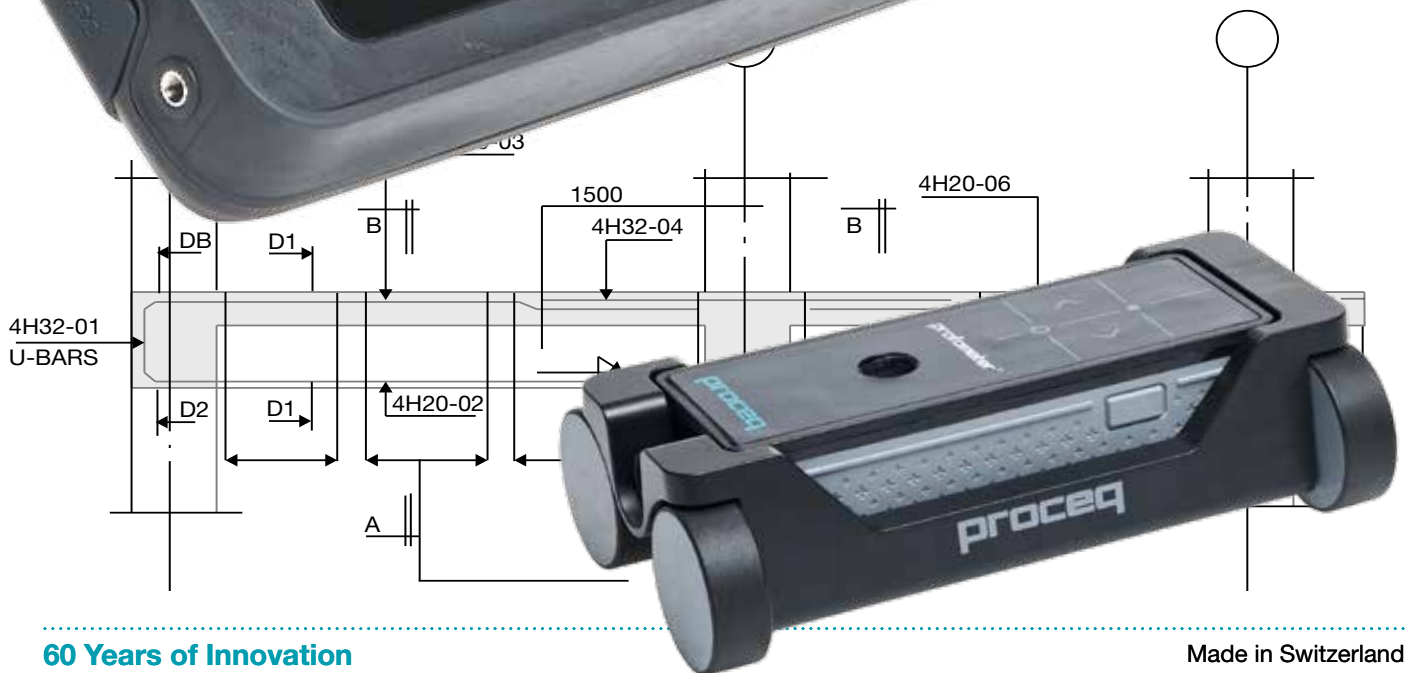

60 Years of Innovation
Design Patent Pending

Made in Switzerland

New Profometer Universal Probe

Increased rebar detection capabilities through higher resolution

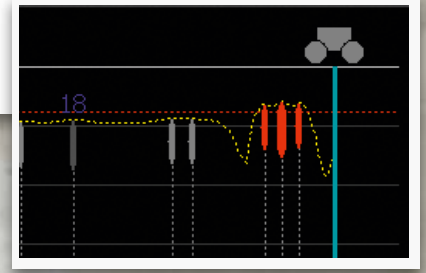

Detachable Probe Cart for smooth measuring with on-board wireless path measuring system



Control buttons directly on the probe

Standard and long range probe

Ergonomic and lightweight design with **soft rubber** for better grip

Probe completely sealed with waterproof connector

Integrated Spot Probe for measurements in corners and where space is limited



LED indicates proximity and location of rebars

Positioning sensor records automatically orientation of the probe (horizontal, vertical, overhead)

Digital interface for **interference free communication** with Profometer Touchscreen

PROFOMETER® TOUCHSCREEN UNIVERSAL

Proceq – History of Innovation since 1954

Proceq SA of Switzerland, founded in 1954, is a leading manufacturer of the highest quality portable instruments for non-destructive testing of materials. The ubiquitous Original Schmidt concrete test hammer, the patented SilverSchmidt (Q-value) and the Carboteq are just an excerpt of Proceq's proud inventions.

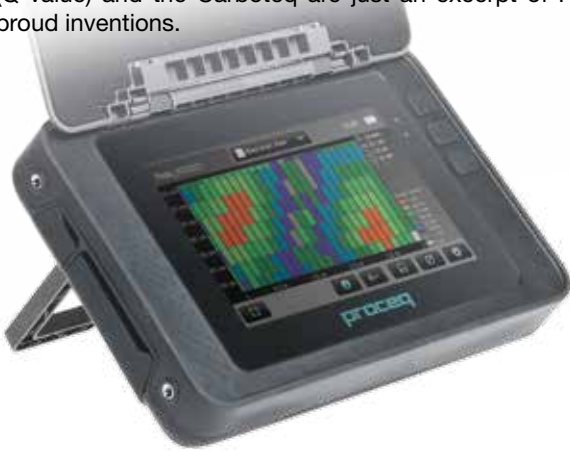

Revolutionary Profometer Touchscreen





As direct successors of the Profometer 5+ S and Scanlog models, **Profometer PM-6 instruments** continue the successful tradition that began 40 years ago representing the sixth Profometer generation.

The Profometer PM-6 use a new generation and design-protected Profometer Touchscreen Unit. The instruments offer unique on-site measuring and analysis functions, and a real time control over the measurement procedure.

- ✓ **Housing specially designed to be used on-site in harsh environments, including carrying strap, integrated stand and sunshield cover**
- ✓ **High resolution colour touchscreen allowing best possible measuring and analysis of the data for an entire working day (Battery lifetime >8h)**
- ✓ **Dual core processor supporting diverse communication and peripheral interfaces**
- ✓ **Future proof investment through direct upgrade possibilities to upcoming Profometer products**

Portfolio and Applications Overview

Proceq's Cover Meter and Expert Rebar Tomography Systems allow comprehensive assessment of a concrete structure.

	Basic Cover Meters		Advanced Cover Meters		
	Profoscope	Profoscope+	Spot	Scan	Cross-Scan
					
Rebar Localization	•	•	•	•	•
Cover Measurement	•	•	•	•	•
Diameter Estimation	•	•	•	•	•
Data Acquisition		•	•	•	•
Statistics		•	•	•	•
Snapshots			•	•	•
Single-Line Scan				•	•
Multi-Line Scan				•	•
Area Scan				•	•
Cross-Line Scan					•
Upgrade Possibilities	• → •		• → •	• → •	• → •

All instruments conform to the following standards and norms:
BS 1881 Part 204, DIN 1045 (Germany) and SN 505 262 (Switzerland).

PROFOMETER® PM-600

ADVANCED COVER METER

Profometer PM-600 Overview

Locate Mode

With the Locate Mode you can precisely detect the rebar location and direction as well as measure the cover and the rebar diameter.

- ✓ Visual assistance for speed and signal strength control
- ✓ Settings directly accessible on the measurement screen
- ✓ Spot Probe specially for areas with congested rebar arrangements
- ✓ Automatically detects inclined rebars

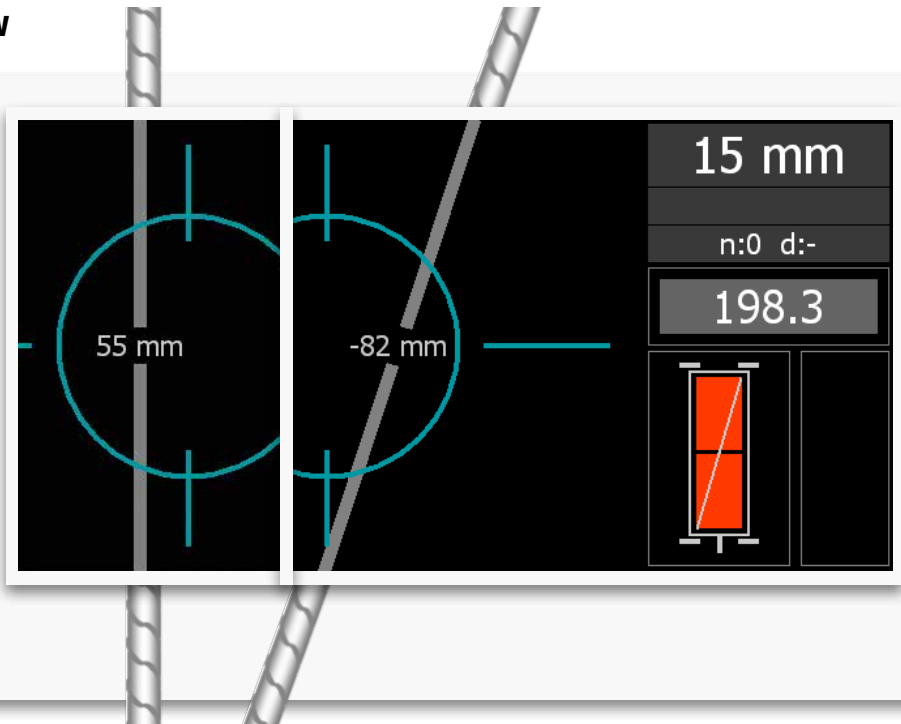

Statistics & Snapshot Views

The statistics and snapshot views allow comprehensive review of the measured data directly on the screen.

The statistics view presents a graphical overview of the distribution of cover measurements. The snapshot view shows cover for each rebar with the diameter displayed as a number.

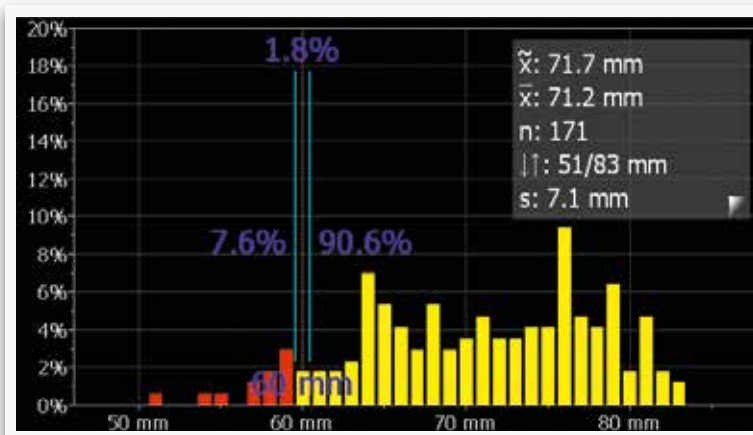

Snapshot view

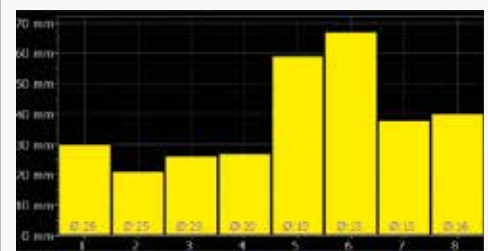

- ✓ Graphical display of measured values and minimum cover set
- ✓ Easy inspection of the measured values directly on the screen
- ✓ Change settings before and after storage
- ✓ Reopen stored files to continue measurements
- ✓ Export the data to a PC via the PM-Link software

PROFOMETER® PM-600

ADVANCED COVER METER

Examples of structured parts with congested rebar arrangements:

- » Columns
- » Girders
- » Slabs over columns



Telescopic extension rod with 3 meter (10 ft) probe cable especially suited for ceilings, high columns and comfortable floor scanning



PROFOMETER® PM-630 ADVANCED SCAN COVER METER

Profometer PM-630 Overview

The sophisticated Profometer PM-630 augments the application range of the Profometer PM-600 with the Line and Area Scan Modes and an extensive choice of statistical views.

Single-Line Scan

Linear scan of the cover across the first layer of rebars over a long distance, with or without diameter measurement.

- ✓ Measuring over long distances
- ✓ Increased rebar detection capabilities (higher resolution)
- ✓ Zoom in to scale rebars according to your needs
- ✓ Display with cover curve or signal strength curve

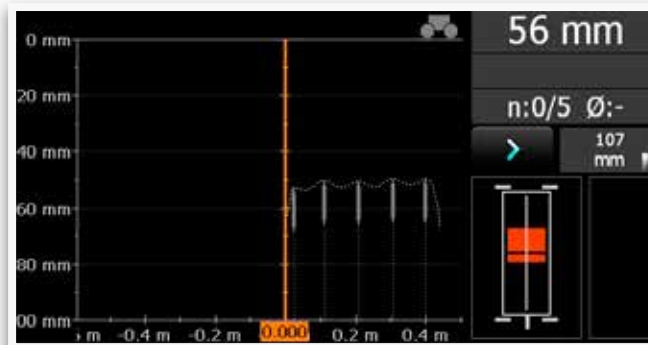

Change probe position during measurement

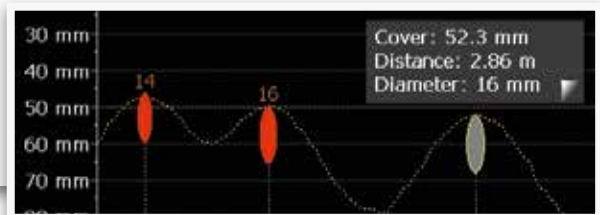

Red color for easy identification of minimum cover violation

Multi-Line Scan

Multiple linear scans across the first layer of rebars over a rectangular area. Cover, diameter and signal strength spectrum are shown in one view. Each line can be viewed individually in the Single-Line View.

- ✓ Color classification depending on cover and rebar diameter settings
- ✓ Signal strength spectrum for further evaluation

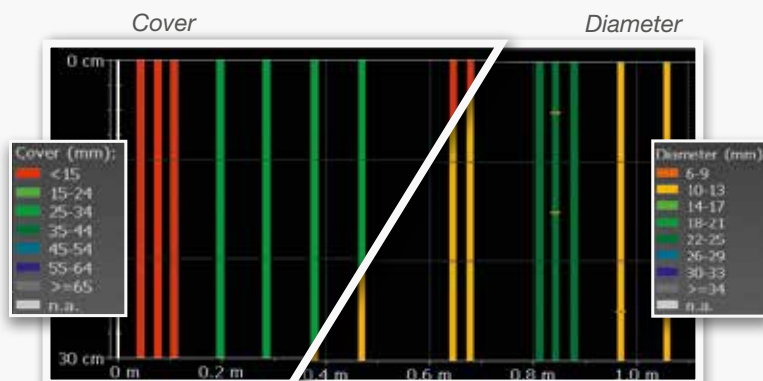

Signal strength spectrum

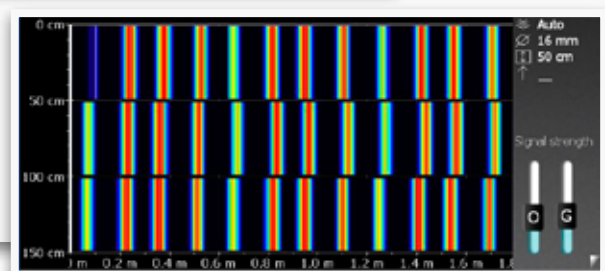

PROFOMETER® PM-630 ADVANCED SCAN COVER METER

Area Scan

The grid display of the Area Scan Mode allows a simplified view of the measured cover data.

It is best suited for a combination with potential field measurements.

- ✓ Individual grid size can be selected
- ✓ Use in combination with Canin+ half-cell potential measurements for corrosion analysis

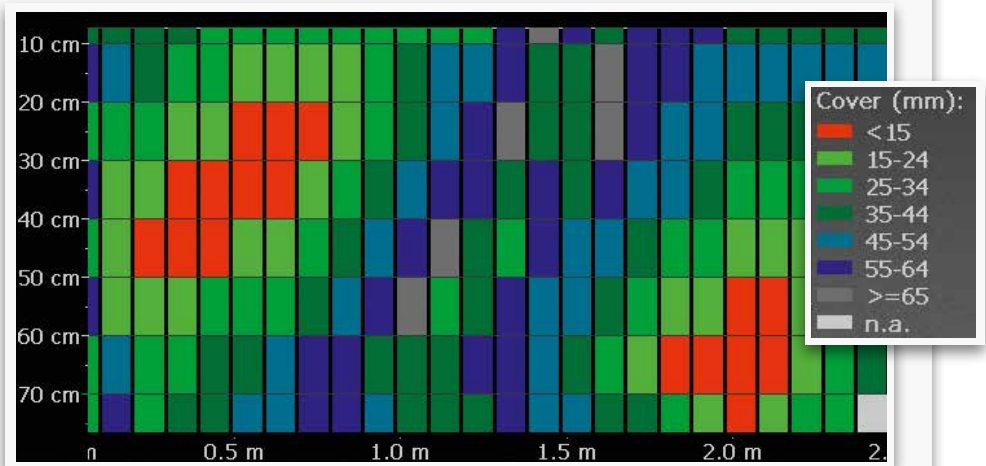

Use the Multi-Line and Area Scan for:

- » Retaining walls
- » Concrete slab soffits
- » Bridge slabs
- » Reinforced walls and slabs

Special statistic view according to DBV*

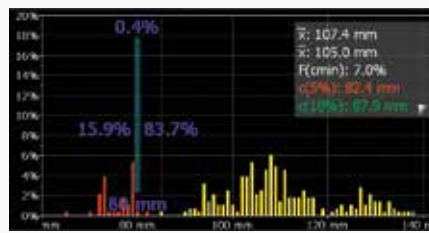

*German Concrete and Construction Association

PROFOMETER® PM-650 ADVANCED CROSS-SCAN COVER METER

Profometer PM-650 Overview

Discover the Profometer PM-650 extending the features of the Profometer PM-630 with the unique Cross-Line Scan measuring mode and analysis functions.

Cross-Line Scan

The Cross-Line Scan extends the Multi-Line Scan with the unique functionality of combining scans in the X- and Y-directions.

✓ **Measuring the rebars of the first and second layer typically arranged in a rectangular mesh**

✓ **The signal strength spectrum can be seen in addition to the cover and diameter**

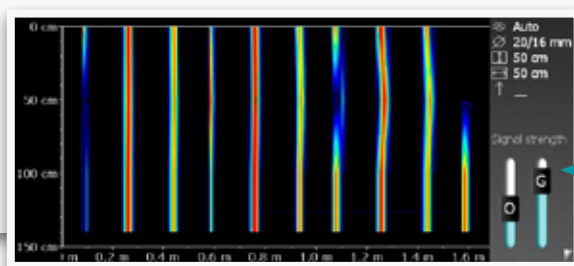
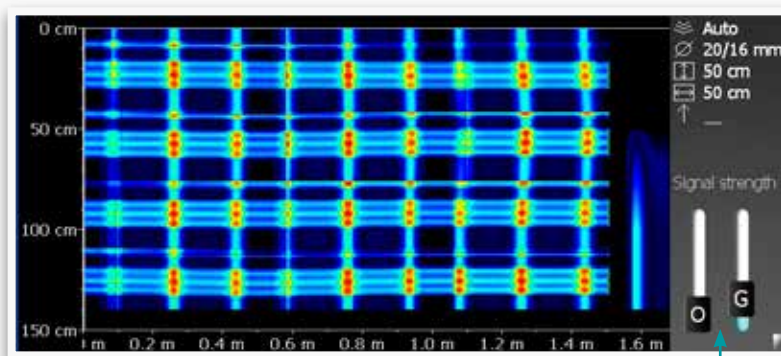

By changing the Offset- and Gain-slider positions the signal strength range and resolution can be set and accordingly shown in a color spectrum, for example to display the first layer of rebars.

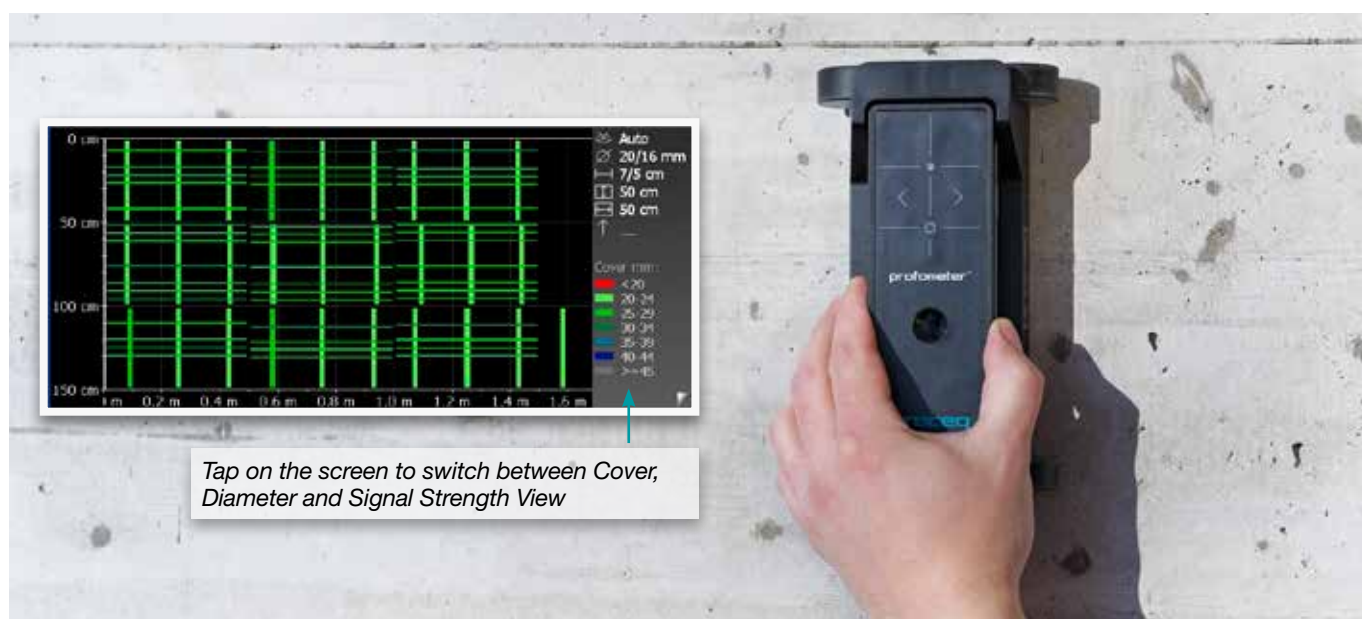

Tap on the screen to switch between Cover, Diameter and Signal Strength View

NDT Concrete Cover Meter to Reinforcing Bar Detection Training Concept

Proceq's training modules are strongly focused on a practical approach to routine testing of in-situ concrete quality using the **whole range of our cover meter products**.

Training facilities are located at Proceq headquarters in Schwerzenbach (Switzerland), Chicago (USA) and Singapore. All training modules are conducted in English (German, French and Spanish can be organized on demand).

Training fees include all necessary training material and documentation and exclude all travel, accommodation and meals. Course dates are determined by Proceq. Please contact your local Proceq representative.

Essentials of Cover Meter Detection using the Electromagnetic Pulse Induction Technology

Description	Prerequisites	Duration	Locations	Course No.
Characteristics of concrete; overview of NDT methods; electromagnetic pulse induction technology principle and methods for cover measurement, rebar localization and diameter measurement; product and practical training (Profoscope, Profometer PM-6).	Any technical background or prior experience with NDT products will allow quicker and deeper comprehension of the course material.	1 day	<ul style="list-style-type: none"> » Schwerzenbach (Zuerich, Switzerland) » Chicago Illinois (United States of America) » Singapore 	970 00 500

Profoscope(+)

Basic Cover Meter

Get the most trusted instrument for rebar detection, cover depth and rebar diameter measurements.

The Profoscope instruments are used to determine the location and concrete cover of the reinforcing bars in reinforced concrete structures. The instruments can also estimate the bar diameter. The Profoscope's rebar detection function and its capability to identify the mid-point between two rebars are groundbreaking.

- » **Versatility:** Rebar location and orientation, cover measurement and rebar diameter assessment all provided by a single, fully integrated, cordless instrument.
- » **Ease of use:** The intuitive user interface and the the realtime visualization of the rebars make the instrument very easy to use.
- » **Durability:** Sealed housing for use in rough environment with replaceable protection cover for long lasting performance, over a wide temperature range.



PROFOMETER® PM-6

ADVANCED COVER METERS

Ordering Information

Units

PART NO.	DESCRIPTION
392 10 001	Profometer PM-600 consisting of Profometer Touchscreen, universal probe with probe cart, probe cable 1.5 m (5 ft), power supply, USB cable, chalk, DVD with software, documentation, carrying strap and carrying case
392 20 001	Profometer PM-630 consisting of Profometer Touchscreen, universal probe with probe cart, probe cable 1.5 m (5 ft), power supply, USB cable, chalk, DVD with software, documentation, carrying strap and carrying case
392 30 001	Profometer PM-650 consisting of Profometer Touchscreen, universal probe with probe cart, probe cable 1.5 m (5 ft), power supply, USB cable, chalk, DVD with software, documentation, carrying strap and carrying case
391 10 000	Profoscope unit consisting of Profoscope, start-up test kit, batteries, canvas bag, carrying strap, chalk, documentation
391 20 000	Profoscope+ unit consisting of Profoscope+, start-up test kit, batteries, memory card, USB-cable, canvas bag, carrying strap, chalk, documentation, Profolink software

Upgrades

392 00 115	Software Upgrade from Profometer PM-600 to PM-630
392 00 116	Software Upgrade from Profometer PM-630 to PM-650

Accessories

392 40 040	Profometer PM-6 telescopic extension rod 1.6 m (5.3 ft) with probe cable 3 m (10 ft)
390 00 270	Profometer test block
327 01 053	Quick charger
327 01 033	Battery complete
392 00 004S	Profometer PM-6 self-adhesive protective film for probe (set of 3)

Proceq SA

Ringstrasse 2
8603 Schwerzenbach
Switzerland
Phone: +41 (0)43 355 38 00
Fax: +41 (0)43 355 38 12
info@proceq.com
www.proceq.com

810 392 01E ver 08 2014 © Proceq SA, Switzerland. All rights reserved.

Technical Specification

Cover Measuring Range	Up to 185 mm (7.3 inch)
Cover Measuring Accuracy	± 1 to ± 4 mm (0.04 to 0.16 inch)
Measuring Resolution	Depending on diameter and cover
Path Measuring Accuracy on smooth Surface	± 3 mm (0.12 inch) + 0.5% to 1.0% of measured length
Diameter Measuring Range	Cover up to 63 mm (2.50 inch), Diameter up to 40 mm (# 12)
Diameter Measuring Accuracy	± 1 mm (± # 1)
Display	7" colour display 800x480 pixels
Memory	Internal 8 GB Flash memory
Regional Settings	Metric and imperial units and multi-language supported
Power Input	12 V +/-25 % / 1.5 A
Dimensions	250 x 162 x 62 mm
Weight (of display device)	About 1525 g (incl. Battery)
Battery	Lithium Polymer, 3.6 V, 14.0 Ah
Battery Lifetime	> 8h (in standard operating mode)
Humidity	< 95 % RH, non condensing
Operating Temperature	0°C – 30°C (Charging*, instrument on) 0°C – 40°C (Charging*, instrument off) -10°C – 50°C (Non-charging)
IP Classification	Touchscreen IP54, Probe IP67
Standards and Guidelines	BS 1881 part 204, Din 1045, SN 505262, DGZfP-guideline B2, CE certification

*charging equipment is for indoor use only (no IP classification)

Service and Support

Proceq is committed to providing the best support and service available in the industry through the Proceq certified service centers worldwide. This results in a complete support for the Profometer PM-6 by means of our global service and support facilities.

Warranty Information

Each instrument is backed by the standard Proceq warranty and extended warranty options.

- » Electronic portion of the instrument: 24 months
- » Mechanical portion of the instrument: 6 months

Subject to change without notice. All information contained in this documentation is presented in good faith and believed to be correct. Proceq SA makes no warranties and excludes all liability as to the completeness and/or accuracy of the information. For the use and application of any product manufactured and/or sold by Proceq SA explicit reference is made to the particular applicable operating instructions.

The Profometer Measuring Range

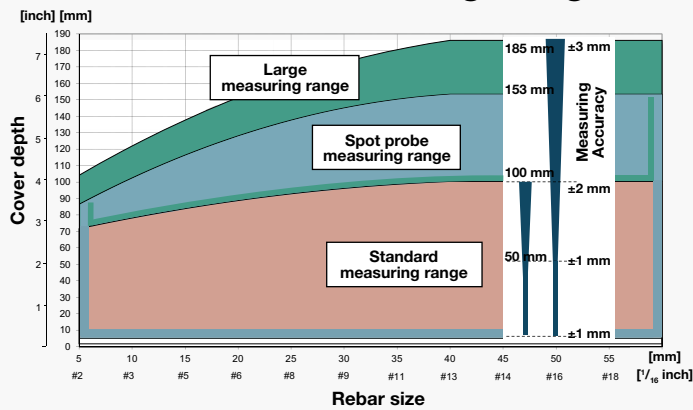

Unsurpassed Resolution

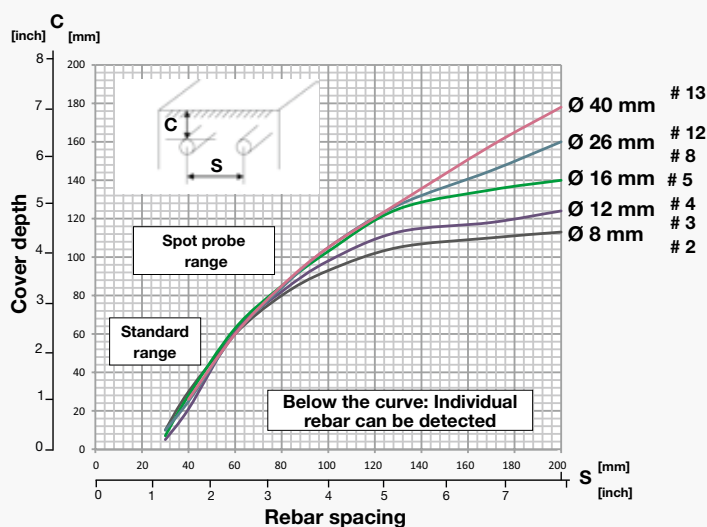

The Technology

The Profometer PM-6 instruments use **electromagnetic pulse induction technology** to detect rebars. Multiple coil arrangements in the probe are periodically charged by current pulses and thus generate a magnetic field.

On the surface of any electrically conductive material which is in the magnetic field eddy currents are produced. They induce a magnetic field in the opposite direction. The resulting change in voltage can be utilized for the measurement.

Advanced signal processing allows localization of a rebar, determination of the cover and estimation of the rebar diameter. This method is unaffected by all non conductive materials such as concrete, wood, plastics, bricks etc.

However any kind of conductive materials within the magnetic field will have an influence on the measurement.

